

**POWER PURCHASE AGREEMENT
(RENEWABLE ENERGY – SOLAR)**

BETWEEN

PAVANT SOLAR II LLC

AND

PACIFICORP

TABLE OF CONTENTS

	Page
SECTION 1 DEFINITIONS, RULES OF INTERPRETATION.....	2
1.1 Defined Terms.	2
1.2 Rules of Interpretation	14
1.2.1 General.....	14
1.2.2 Terms Not to be Construed For or Against Either Party	14
1.2.3 Headings	14
1.2.4 Examples.....	15
1.2.5 Interpretation with FERC Orders.....	15
SECTION 2 TERM; FACILITY DEVELOPMENT	15
2.1 Term; Inter-jurisdictional Cost Allocation.....	15
2.2 Adverse Order.....	16
2.3 Milestones	16
2.4 Project Construction and Delay Damages	16
2.5 Damages Calculation	17
2.6 Damages Invoicing	17
2.7 PacifiCorp's Right to Monitor.....	17
2.8 Tax Credits.....	19
SECTION 3 REPRESENTATIONS AND WARRANTIES	19
3.1 Mutual Representations and Warranties	19
3.1.1 Organization.....	19
3.1.2 Authority.....	19
3.1.3 Corporate Actions	19
3.1.4 No Contravention.....	19
3.1.5 Valid and Enforceable Agreement.....	19
3.1.6 Litigation.....	19
3.2 Seller's Further Representations and Warranties	20
3.2.1 Authority.....	20
3.2.2 No Contravention.....	20
3.2.3 Required Facility Documents	20
3.2.4 Delivery of Energy.....	20
3.2.5 Control of Premises.....	21
3.3 No Other Representations or Warranties	21

TABLE OF CONTENTS

(continued)

Page

3.4	Continuing Nature of Representations and Warranties; Notice.....	21
SECTION 4 DELIVERIES OF NET OUTPUT AND GREEN TAGS.....		21
4.1	Purchase and Sale	21
4.2	No Sales to Third Parties	22
4.3	Title and Risk of Loss of Net Output.....	22
4.4	Curtailed	22
4.5	PacifiCorp as Merchant.....	23
4.7	Capacity Rights.....	23
4.7.1	Purchase and Sale of Capacity Rights.	24
4.7.2	Representation Regarding Ownership of Capacity Rights	24
4.7.3	Further Assurances.....	24
SECTION 5 CONTRACT PRICE; COSTS.....		24
5.1	Contract Price; Includes Green Tags and Capacity Rights.....	24
5.1.1	Test Energy and Net Output Before Later of Commercial Operation Date and Scheduled Operation Date.	24
5.1.2	Net Output After The Later of Commercial Operation Date and Scheduled Commercial Operation Date.....	24
5.2	Costs and Charges.....	24
5.3	Station Service	25
5.4	Taxes	25
5.5	Costs of Ownership and Operation.....	25
5.6	Rates Not Subject to Review	25
SECTION 6 OPERATION AND CONTROL		26
6.1	As-Built Supplement.....	26
6.2	Standard of Facility Operation.....	26
6.2.1	General.....	26
6.2.2	Qualified Operator	26
6.2.3	Fines and Penalties.....	27
6.3	Interconnection	27
6.4	Coordination with System.....	27
6.5	Outages	27
6.5.1	Planned Outages.....	27
6.5.2	Maintenance Outages.....	27

TABLE OF CONTENTS

	(continued)	Page
	6.5.3 Forced Outages	28
	6.5.4 Notice of Deratings and Outages	28
	6.5.5 Effect of Outages on Estimated Output	28
6.6	Scheduling.....	29
	6.6.1 Cooperation and Standards	29
	6.6.2 Schedule Coordination.....	29
6.7	Forecasting.....	29
	6.7.1 Long-Range Forecasts	29
	6.7.2 Day-Ahead Forecasts and Updates	29
	6.7.3 Basis of Forecasts.	30
6.8	Increase in Nameplate Capacity Rating; New Project Expansion or Development	30
6.9	Electronic Communications.....	30
	6.9.1 Telemetry	30
	6.9.2 Interconnection Provider Consent.....	30
	6.9.3 Dedicated Communication Circuit	31
6.10	Reports and Records	31
	6.10.1 Quarterly Reports.....	31
	6.10.2 Electronic Fault Log	31
	6.10.3 Other Information to be Provided to PacifiCorp.....	31
	6.10.4 Information to Governmental Authorities	32
	6.10.5 Data Request	32
	6.10.6 Documents to Governmental Authorities	32
	6.10.7 Environmental Information.....	32
	6.10.8 Operational Reports	33
	6.10.9 Notice of Material Adverse Events.....	33
	6.10.10 Notice of Litigation.....	33
	6.10.11 Additional Information	33
	6.10.12 Confidential Treatment	33
6.11	Financial and Accounting Information	33
6.12	Output Guarantee	34
	6.12.1 Output Guarantee	34

TABLE OF CONTENTS

(continued)

Page

6.12.2	Liquidated Damages for Output Shortfall.....	34
6.12.3	Annual Invoicing	35
6.13	Access Rights.....	35
6.14	Facility Images.....	36
SECTION 7 QUALIFYING FACILITY STATUS		36
7.1	Seller's QF Status	36
7.2	QF Facility	36
SECTION 8 SECURITY AND CREDIT SUPPORT		36
8.1	Project Development Security	36
8.1.1	Form and Amount of Project Development Security	37
8.1.2	Use of Project Development Security to Pay Delay Damages	37
8.1.3	Termination of Project Development Security	37
8.2	Default Security	37
8.2.1	Duty to Post Default Security	37
8.4	Intentionally Deleted.....	37
8.5	Step In Rights.....	38
8.5.1	Failure to Achieve Commercial Operation.....	38
8.5.2	License to Operate Facility	38
8.5.3	Not Used.	38
8.5.4	Records and Access	38
8.5.5	Return.....	38
8.5.6	No Assumption	39
8.5.7	Costs and Expenses.....	39
8.6	Annual Financial Statements	39
8.7	Security is Not a Limit on Seller's Liability	39
8.8	Senior Lender Assurances.....	39
SECTION 9 METERING		40
9.1	Installation of Metering Equipment.....	41
9.2	Metering.....	41
9.3	Inspection, Testing, Repair and Replacement of Meters	41
9.4	Metering Costs	41
9.5	Meter Data	41

TABLE OF CONTENTS

(continued)

	Page
9.6 WREGIS Metering.....	41
SECTION 10 BILLINGS, COMPUTATIONS AND PAYMENTS.....	42
10.1 Monthly Invoices	42
10.2 Offsets	42
10.3 Interest on Late Payments	42
10.4 Disputed Amounts	42
10.5 Audit Rights	42
SECTION 11 DEFAULTS AND REMEDIES	42
11.1 Defaults	42
11.1.1 Defaults by Either Party	43
11.1.2 Defaults by Seller.....	43
11.2 Remedies for Failure to Deliver/Receive.....	44
11.2.1 Remedy for Seller's Failure to Deliver	44
11.2.2 Remedy for PacifiCorp's Failure to Purchase	44
11.2.3 Remedy for Seller's Failure to Sell/Deliver Capacity Rights	45
11.3 Termination and Remedies	45
11.4 Termination of Duty to Buy; Memorandum of Agreement.....	46
11.5 Termination Damages	46
11.6 Duty/Right to Mitigate.....	47
11.7 Security	47
11.8 Cumulative Remedies	47
SECTION 12 INDEMNIFICATION AND LIABILITY	47
12.1 Indemnities.....	47
12.1.1 Indemnity by Seller.....	47
12.1.2 Indemnity by PacifiCorp.....	48
12.1.3 Additional Cross Indemnity	48
12.1.4 No Dedication	48
12.1.5 Consequential Damages.....	48
SECTION 13 INSURANCE.....	48
13.1 Required Policies and Coverages.....	48
SECTION 14 FORCE MAJEURE.....	48
14.1 Definition of Force Majeure	48

TABLE OF CONTENTS

(continued)

	Page
14.2 Suspension of Performance.....	49
14.3 Force Majeure Does Not Affect Other Obligations	49
14.4 Strikes	50
14.5 Right to Terminate	50
SECTION 15 SEVERAL OBLIGATIONS	50
SECTION 16 CHOICE OF LAW	50
SECTION 17 PARTIAL INVALIDITY	50
SECTION 18 NON-WAIVER	50
SECTION 19 GOVERNMENTAL JURISDICTION AND AUTHORIZATIONS	51
SECTION 20 SUCCESSORS AND ASSIGNS	51
20.1 Restriction on Assignments	51
20.2 Permitted Assignments	51
SECTION 21 ENTIRE AGREEMENT	51
SECTION 22 NOTICES	51
22.1 Addresses and Delivery Methods	51
22.2 Changes of Address	53
SECTION 23 CONFIDENTIALITY	53
23.1 Confidential Business Information	53
23.2 Duty to Maintain Confidentiality.....	53
23.3 PacifiCorp Regulatory Compliance	54
23.4 Irreparable Injury; Remedies	54
23.5 News Releases and Publicity	54
SECTION 24 DISAGREEMENTS	54
24.1 Negotiations	54
24.2 Mediation; Technical Expert.....	54
24.2.1 Mediation	54
24.2.2 Technical Expert	56
24.3 Place of Contract Formation; Choice of Forum.....	57
24.4 Settlement Discussions	57
24.5 Waiver of Jury Trial.....	57
24.6 Specific Performance	58

EXHIBITS

Exhibit A	Estimated Monthly Output
Exhibit B	NERC Event Types
Exhibit C	Example Calculation of Delay Damages
Exhibit D	Start-Up Testing
Exhibit E	Example Calculation of PacifiCorp's Cost to Cover
Exhibit F	Sample Report From Firm Market Price Index
Exhibit G	Approved Licensed Professional Engineers
Exhibit H	Permits
Exhibit 2.7	PacifiCorp's Initial Designated Representatives
Exhibit 3.2.3	Required Facility Documents
Exhibit 3.2.5	Leases
Exhibit 4.6(1)	Green Tags Attestation and Bill of Sale
Exhibit 4.6(2)	Qualified Reporting Entity Services Agreement
Exhibit 5.1	Contract Price
Exhibit 6.1	Description of Facility and Premises
Exhibit 8.2.1	Form of Guaranty
Exhibit 9.2	Point of Delivery/Interconnection Facilities
Exhibit 9.5	Seller Authorization to Release Generation Data to PacifiCorp
Exhibit 11.4	Form of Memorandum of Power Purchase Agreement
Exhibit 13	Required Insurance

**POWER PURCHASE AGREEMENT
(RENEWABLE ENERGY)**

THIS POWER PURCHASE AGREEMENT (RENEWABLE ENERGY) (this "Agreement") dated as of _____, 2015, is entered into between Pavant Solar II LLC, a Delaware limited liability company (the "Seller") and PacifiCorp, an Oregon corporation acting in its merchant function capacity ("PacifiCorp"). Seller and PacifiCorp are sometimes hereinafter referred to collectively as the "Parties" and individually as a "Party."

WHEREAS, Seller intends to construct, own, operate and maintain a solar-powered generation facility for the generation of electric energy located in Millard County, Utah with an expected nameplate capacity rating of [REDACTED] MW (AC) (the "Facility").

WHEREAS, Seller intends to operate the Facility as a Qualifying Facility ("QF").

WHEREAS, Seller expects that the Facility will deliver to PacifiCorp [REDACTED] MWh of Net Output per calendar year, as adjusted due to annual degradation. Seller estimates that the Net Output will be delivered during each calendar year according to the estimates of monthly output set forth in Exhibit A. Seller acknowledges that PacifiCorp will include this amount of energy in PacifiCorp's resource planning.

WHEREAS, Seller desires to sell, and PacifiCorp desires to purchase, the Net Output expected to be delivered by the Facility and associated Green Tags in accordance with PacifiCorp's Utah Schedule 38 and the terms and conditions hereof.

WHEREAS, The rates, terms and conditions in this Agreement are in accordance with the rates, terms, and conditions approved by the Commission for purchases from Qualifying Facilities.

WHEREAS, The rates, terms and conditions in this Agreement are in accordance with the rates, terms, and conditions approved by the Commission in Docket No. 03-035-14 and Docket No. 12-035-100 for purchases from Qualifying Facilities.

WHEREAS, PacifiCorp intends to designate Seller's Facility as a Network Resource for the purposes of serving network load.

WHEREAS, For purposes of inter-jurisdictional cost allocation, this Agreement is a "New QF Contract" under the PacifiCorp Inter-Jurisdictional Cost Allocation 2010 Protocol and, as such, its costs are allocated as a system resource unless any portion of the cost of this Agreement exceeds the cost PacifiCorp would have otherwise incurred acquiring comparable resources, in which case such excess costs shall be assigned on a situs basis.

WHEREAS, Seller shall obtain any necessary retail electric service from PacifiCorp pursuant to the applicable PacifiCorp retail electric service schedule.

NOW, THEREFORE, in consideration of the foregoing and the mutual promises set forth below and for other good and valuable consideration, the receipt and sufficiency of which are hereby acknowledged, the Parties mutually agree as follows:

SECTION 1
DEFINITIONS, RULES OF INTERPRETATION

1.1 Defined Terms. Unless otherwise required by the context in which any term appears, initially capitalized terms used herein shall have the following meanings:

"AAA" means the American Arbitration Association.

"AC" means alternating current.

"Abandonment" means (a) the relinquishment of all possession and control of the Facility by Seller, other than pursuant to a transfer permitted under this Agreement, or (b) if after commencement of the construction, testing, and inspection of the Facility, and prior to the Commercial Operation Date, there is a complete cessation of the construction, testing, and inspection of the Facility for 90 consecutive days by Seller and Seller's contractors, but only if such relinquishment or cessation is not caused by or attributable to an Event of Default of, or request by, PacifiCorp, or an event of Force Majeure.

"Affiliate" means, with respect to any entity, each entity that directly or indirectly controls, is controlled by, or is under common control with, such designated entity, with "control" meaning the possession, directly or indirectly, of the power to direct management and policies, whether through the ownership of voting securities or by contract or otherwise. Notwithstanding the foregoing, with respect to PacifiCorp, Affiliate shall only include Berkshire Hathaway Energy and its direct, wholly owned subsidiaries.

"Agreement" is defined in the Recitals.

"As-built Supplement" is a supplement to be added to Exhibit 6.1 that describes the Facility as actually built, pursuant to Section 6.1 and includes an American Land Title Association survey of the Premises.

"Business Day" means any day on which banks in Salt Lake City, Utah are not authorized or required by Requirements of Law to be closed, beginning at 6:00 a.m. and ending at 5:00 p.m. local time in Utah.

"CAMD" means the Clean Air Markets Division of the Environmental Protection Agency or successor administrator, or any state or federal entity given jurisdiction over a program involving transferability of Green Tags.

"Capacity Rights" means any current or future defined characteristic, certificate, tag (but not Green Tags), credit, ancillary service or attribute thereof, or accounting construct, including any of the same counted towards any current or future resource adequacy or reserve requirements, associated with the electric generation capability and capacity of the Facility or the Facility's capability and ability to produce energy; provided, that Capacity Rights shall not include any ancillary services that Seller is expressly obligated to provide to the Interconnection

Provider pursuant to the terms of the Interconnection Agreement. Capacity Rights are measured in MW and do not include ITCs, any Tax Credits, or any other tax incentives existing now or in the future associated with the construction, ownership or operation of the Facility.

"Commercial Operation" means that not less than the Required Percentage of the Expected Nameplate Capacity Rating of the Facility is fully operational and reliable and the Facility is fully interconnected, fully integrated, and synchronized with the System, evidence of which shall be Seller's responsibility to receive or obtain, and which occurs when all of the following events (a) have occurred, and (b) remain simultaneously true and accurate as of the date and moment on which Seller gives PacifiCorp notice that Commercial Operation has occurred:

(i) PacifiCorp shall have received a certificate addressed to PacifiCorp from a Licensed Professional Engineer that is licensed in the state of Utah stating: (1) the Nameplate Capacity Rating of the Facility at the anticipated time of Commercial Operation, of at least the Required Percentage of the Expected Nameplate Capacity Rating, and (2) that the Facility is able to generate electric energy reliably in amounts expected by this Agreement and in accordance with all other terms and conditions hereof; and, (3) Start-Up Testing of the Facility has been completed;

(ii) PacifiCorp shall have received a certificate addressed to PacifiCorp from a Licensed Professional Engineer stating that, in accordance with the Generation Interconnection Agreement, all required Interconnection Facilities have been constructed, all required interconnection tests have been completed and the Facility is physically interconnected with the System in conformance with the Generation Interconnection Agreement and able to deliver energy consistent with the terms of this Agreement.

(iii) PacifiCorp shall have received a certificate from a Licensed Professional Engineer or an opinion from an attorney licensed in the state of Utah that is not an employee of Seller (or any Affiliate, parent or subsidiary) and has no financial interest in the Facility addressed to PacifiCorp stating that Seller has obtained or entered into all Required Facility Documents identified on Exhibit 3.2.3 as being required to be obtained prior to Commercial Operation. Seller shall provide copies of any or all Required Facility Documents requested by PacifiCorp.

(iv) PacifiCorp has received confirmation from the Network Service Provider that the Facility has been designated as a Network Resource and PacifiCorp has received confirmation from the Network Service Provider that the transmission service request has been granted in sufficient capacity to meet or exceed the Maximum Delivery Rate and the Seller has paid all currently known and invoiced costs associated with any requirements of the transmission service request.

Seller shall provide written notice to PacifiCorp stating when Seller believes that the Facility has achieved Commercial Operation and its Nameplate Capacity Rating accompanied by the certificates described above. PacifiCorp shall have ten (10) Business Days after receipt either to confirm to Seller that all of the conditions to Commercial Operation have been satisfied or have occurred, or to state with specificity what PacifiCorp reasonably believes has not been satisfied.

If, within such ten (10) Business Day period, PacifiCorp does not respond or notifies Seller confirming that the Facility has achieved Commercial Operation, the original date of receipt of Seller's notice shall be the Commercial Operation Date. If PacifiCorp notifies Seller within such ten (10) Business Day period that PacifiCorp reasonably believes the Facility has not achieved Commercial Operation, Seller shall address the concerns stated in PacifiCorp's notice to the satisfaction of PacifiCorp. In the event PacifiCorp provides notice of deficiency with regards to the information submitted to establish the Commercial Operation Date, then the Commercial Operation Date shall be the date upon which Seller has addressed the concerns stated in PacifiCorp's notice to PacifiCorp's reasonable satisfaction. If Commercial Operation is achieved at less than 100 percent of the Expected Nameplate Capacity Rating and Seller informs PacifiCorp that Seller intends to bring the Facility above the Required Percentage, not to exceed 100 percent of the Expected Nameplate Capacity Rating, Seller shall provide PacifiCorp with a list of all items to be completed in order to achieve Final Completion ("Final Completion Punch List"). All items on the Final Completion Punch List must be completed on or before the 120th day after the Commercial Operation Date.

"Commercial Operation Date" means the date that Commercial Operation is achieved for the Facility but in no event earlier than 90 calendar days before the Scheduled Commercial Operation Date.

"Commission" means the Utah Public Service Commission.

"Confidential Business Information" is defined in Section 23.1.

"Contract Interest Rate" means the lesser of (a) the highest rate permitted under Requirements of Law or (b) 200 basis points per annum plus the rate per annum equal to the publicly announced prime rate or reference rate for commercial loans to large businesses in effect from time to time quoted by Citibank, N.A. as its "prime rate." If a Citibank, N.A. prime rate is not available, the applicable prime rate shall be the announced prime rate or reference rate for commercial loans in effect from time to time quoted by a bank with \$10 billion or more in assets in New York City, N.Y., selected by the Party to whom interest is being paid.

"Contract Price" means the applicable price, expressed in \$/MWh for Net Output and Capacity Rights stated in Section 5.1.

"Contract Year" means any consecutive 12-month period during the Term, commencing at 00:00 hours on the Commercial Operation Date or any of its anniversaries and ending at 24:00 hours on the last day of such 12-month period.

"Credit Requirements" means a senior, unsecured long term debt rating (or corporate rating if such debt rating is unavailable) of (a) BBB- or greater from S&P, or (b) Baa3 or greater from Moody's; provided that if (a) or (b) is not available, an equivalent rating as determined by PacifiCorp through an internal process review and utilizing a proprietary credit scoring model developed in conjunction with a third party.

"Default Security" is defined in Section 8.2.1.

"Delay Damages" for any given day are equal to (a) the Expected Energy, expressed in MWhs per year, divided by 365, multiplied by (b) PacifiCorp's Cost to Cover.

"Effective Date" is defined in Section 2.1.

"Electric System Authority" means each of NERC, WECC, WREGIS, an RTO, a regional or sub-regional reliability council or authority, and any other similar council, corporation, organization or body of recognized standing with respect to the operations of the electric system in the WECC region, as such are applicable to the Seller or PacifiCorp.

"Energy Imbalance Market" means generation facilities electrically located within PacifiCorp's balancing authority areas that are, from time to time, bid in to or otherwise subject to dispatch instructions issued or originating from the Market Operator.

"Environmental Attributes" means any and all claims, credits, benefits, emissions reductions, offsets, and allowances, howsoever entitled, resulting from the avoidance of the emission of any gas, chemical, or other substance to the air, soil or water. Environmental Attributes include but are not limited to: (a) any avoided emissions of pollutants to the air, soil, or water such as (subject to the foregoing) sulfur oxides (SOx), nitrogen oxides (NOx), carbon monoxide (CO), and other pollutants; and (b) any avoided emissions of carbon dioxide (CO2), methane (CH4), and other greenhouse gases (GHGs) that have been determined by the United Nations Intergovernmental Panel on Climate Change to contribute to the actual or potential threat of altering the Earth's climate by trapping heat in the atmosphere. Environmental Attributes do not include (i) ITCs or any Tax Credits, or certain other tax incentives existing now or in the future associated with the construction, ownership or operation of the Facility, (ii) matters designated by PacifiCorp as sources of liability, or (iii) adverse wildlife or environmental impacts.

"Environmental Contamination" means the introduction or presence of Hazardous Materials at such levels, quantities or location, or of such form or character, as to constitute a violation of federal, state or local laws or regulations, and present a material risk under federal, state or local laws and regulations that the Premises will not be available or usable for the purposes contemplated by this Agreement.

"Event of Default" is defined in Section 11.1.

"Example" means an example of certain calculations to be made hereunder. Each Example is for purposes of illustration only and is not intended to constitute a representation, warranty or covenant concerning the matters assumed for purposes of each Example.

"Expected Energy" means ■■■ MWh of Net Output per year measured at the Point of Delivery, which is Seller's best estimate of the projected long-term average annual Net Output production based upon typical solar conditions at the Facility as determined by a Solar Performance Modeling Program, delivered to the Point of Delivery and the Expected Nameplate Capacity Rating. Seller estimates that the Net Output will be delivered during each calendar year according to the estimates of monthly output set forth in Exhibit A. If at Final Completion the Facility's Nameplate Capacity Rating is less than the Expected Nameplate Capacity Rating, Expected Energy shall be reduced or prorated by ■■■ MWh per year for each full MW of

Nameplate Capacity Rating below the Expected Nameplate Capacity Rating. Seller acknowledges that PacifiCorp will include Expected Energy in PacifiCorp's resource planning. PacifiCorp acknowledges that solar exposure is a variable resource and that the Facility's actual annual output of Net Output and Green Tags in the ordinary course in any given year will be subject to variation caused by differences in the actual solar exposure at the Facility from year to year.

"Expected Nameplate Capacity Rating" means [REDACTED] MW (AC), the expected Nameplate Capacity Rating of the Facility.

"Expected Output" means [REDACTED] MWh for each [REDACTED] MW of Nameplate Capacity Rating (and as adjusted, if applicable, on a pro rata basis for the Facility Nameplate Capacity Rating at the time of Final Completion) in the first full Contract Year, reduced by an annual degradation factor of 0.5% per Contract Year.

"Facility" is defined in the Recitals and is more fully described in attached Exhibit 6.1 and includes the photovoltaic power generating equipment, including panels and inverters, and all other equipment, devices, associated appurtenances owned, controlled, operated and managed by Seller in connection with, or to facilitate, the production, generation, transmission, delivery, or furnishing of electric energy by Seller to PacifiCorp and required to interconnect with the System.

"Facility Financing Date" means the closing date for the construction financing for the Facility between Seller or Seller's Affiliates and a Lender.

"FERC" means the Federal Energy Regulatory Commission.

"Final Completion" means the Facility is fully operational and reliable, at or greater than the Required Percentage of the Expected Nameplate Capacity Rating, and fully interconnected, fully integrated, and synchronized with the Network Service Provider's System, as evidenced (to the reasonable satisfaction of PacifiCorp) by the completion of all items set forth on the Final Completion Punch List, modified if necessary to reflect the Nameplate Capacity Rating.

"Final Completion Punch List" is defined in the definition of "Commercial Operation."

"Firm Market Price Index" means (a) 93 percent of the average price reported by Intercontinental Exchange, Inc. ("ICE") Day-Ahead Palo Verde On-Peak Index, for On-Peak Hours, and (b) 93 percent of the average price reported on the ICE Day-Ahead Palo Verde Off-Peak Index, for Off-Peak Hours. If either index is not available for a given period, for purposes of calculations hereunder, the Firm Market Price Index shall be deemed to equal the volumetrically-weighted average price derived from data published by ICE for the same number of days immediately preceding and immediately succeeding the period in which the index in question was not available, regardless of which days of the week are used for this purpose. If the Firm Market Price Index or its replacement or any component of that index or its replacement ceases to be published or available, or useful for its intended purpose hereunder, during the Term, the Parties shall agree upon a replacement Firm Market Price Index or component an

index or component that, after any necessary adjustments, provides the most reasonable substitute quotation of the daily price of electricity for the applicable periods.

"Force Majeure" is defined in Section 14.1.

"Forced Outage" means NERC Event Types U1, U2 and U3, as set forth in attached Exhibit B, in each case, that affects more than ten percent (10%) of the Nameplate Capacity Rating, and specifically excludes any Maintenance Outage or Planned Outage.

"Generation Interconnection Agreement" means the large generator interconnection agreement to be entered into separately between Seller and Interconnection Provider concerning the Interconnection Facilities.

"Governmental Authority" means any supranational, federal, state or other political subdivision thereof, having jurisdiction over Seller, PacifiCorp or this Agreement, including any municipality, township or county, and any entity or body exercising executive, legislative, judicial, regulatory or administrative functions of or pertaining to government, including any corporation or other entity owned or controlled by any of the foregoing.

"Green Tags" means (a) the Environmental Attributes associated with all Output, together with (b) the Green Tag Reporting Rights associated with such energy and Environmental Attributes, however commercially transferred or traded under any or other product names, such as "Renewable Energy Credits," "Green-e Certified," or otherwise. One Green Tag represents the Environmental Attributes made available by the generation of one MWh of energy from the Facility.

"Green Tags Price Component" means: (1) the price for Green Tags determined by arithmetically averaging quotes for Green Tags from three nationally recognized independent Green Tag brokers selected by PacifiCorp pursuant to which PacifiCorp could reasonably purchase substitute Green Tags similar to those Green Tags that Seller failed to deliver, with delivery terms, vintage period and any renewable program certification eligibility that are similar to those contained herein, calculated as of the date of default or as soon as reasonably possible thereafter; or (2) if after the Effective Date a liquid market for Green Tags exists, the price established for Green Tags from that established liquid market for Green Tags in a form and location that PacifiCorp determines reasonably states the market value of the Green Tags delivered hereunder.

"Green Tag Reporting Rights" means the exclusive right of a purchaser of Environmental Attributes to report ownership of Environmental Attributes in compliance with federal or state law, if applicable, and to federal or state agencies or other parties at such purchaser's discretion, and include reporting under Section 1605(b) of the Energy Policy Act of 1992, or under any present or future domestic, international, or foreign emissions trading program or renewable portfolio standard.

"Guaranteed Commercial Operation Date" means the date that is 180 days after the Scheduled Commercial Operation Date.

"Hazardous Materials" means any waste or other substance that is listed, defined, designated or classified as or determined to be hazardous under or pursuant to any environmental law or regulation.

"Indemnified Party" is defined in Section 6.2.3(b).

"Indemnifying Party" is defined in Section 6.2.3(b).

"Interconnection Facilities" means all the facilities installed, or to be installed, for the purpose of interconnecting the Facility to the System, including electrical transmission lines, upgrades, transformers and associated equipment, substations, relay and switching equipment, and safety equipment.

"Interconnection Provider" means PacifiCorp Transmission.

"Inverter" means the equipment installed at the Facility to convert direct current from the Solar Panels to alternating current, as described in Exhibit 6.1.

"ITCs" means the investment tax credits established pursuant to Section 48 of the Internal Revenue Code; as such law may be amended or superseded.

"KW" means kilowatt.

"KWh" means kilowatt hour.

"Leases" means the memoranda of lease and redacted leases recorded in connection with the development of the Facility, as the same may be supplemented, amended, extended, restated, or replaced from time to time.

"Lender" means an entity lending money or extending credit (including any financing lease, monetization of tax benefits, transaction with a tax equity investor, backleverage financing or credit derivative arrangement) to Seller or Seller's Affiliates (a) for the construction, term or permanent financing or refinancing of the Facility; (b) for working capital or other ordinary business requirements for the Facility (including for the maintenance, repair, replacement or improvement of the Facility); (c) for any development financing, bridge financing, credit support, and related credit enhancement or interest rate, currency, weather, or Environmental Attributes in connection with the development, construction or operation of the Facility; or (d) for the purchase of the Facility and related rights from Seller.

"Letter of Credit" means an irrevocable standby letter of credit in a form reasonably acceptable to PacifiCorp, naming PacifiCorp as the party entitled to demand payment and present draw requests thereunder that:

- (1) is issued by a Qualifying Institution;
- (2) by its terms, permits PacifiCorp to draw up to the face amount thereof for the purpose of paying any and all amounts owing by Seller hereunder;

(3) if issued by a foreign bank with a U.S. branch, permits PacifiCorp to draw upon the U.S. branch;

(4) permits PacifiCorp to draw the entire amount available thereunder if such letter of credit is not renewed or replaced at least 30 Business Days prior to its stated expiration date;

(5) permits PacifiCorp to draw the entire amount available thereunder if such letters of credit are not increased or replaced as and when provided in Section 8;

(6) is transferable by PacifiCorp to any party to which PacifiCorp may assign this Agreement; and

(7) with respect to the last Contract Year, shall remain in effect for at least 90 days after the end of the Term.

"Liabilities" is defined in Section 12.1.1.

"Licensed Professional Engineer" means a person proposed by Seller and acceptable to PacifiCorp in its reasonable judgment who (a) to the extent mandated by Requirements of Law is licensed to practice engineering in the appropriate engineering discipline for the required certification being made, in the United States, and in all states for which the person is providing a certification, evaluation or opinion with respect to matters or Requirements of Law specific to such state, (b) has training and experience in the engineering disciplines relevant to the matters with respect to which such person is called upon to provide a certification, evaluation or opinion, (c) has no economic relationship, association, or nexus with Seller and is not an employee of its members or Affiliates, other than with the prior written consent of PacifiCorp, for services previously or currently being rendered to Seller or its members or Affiliates, and (d) is not a representative of a consulting engineer, contractor, designer or other individual involved in the development of the Facility, or of a manufacturer or supplier of any equipment installed in the Facility.

"Maintenance Outage" means NERC Event Type MO, as set forth in attached Exhibit B, and includes any outage involving at least 10 percent of the Facility's Net Output that is not a Forced Outage or a Planned Outage.

"Market Operator" means the California Independent System Operator or any other entity performing the market operator function for the Energy Imbalance Market.

"Maximum Delivery Rate" means the maximum hourly rate of delivery of Net Output in MWh from the Facility to the Point of Delivery, calculated on the basis of the Net Output delivered in an hour accruing at an average rate equivalent to the actual Nameplate Capacity Rating.

"Moody's" means Moody's Investor Services, Inc.

"Mountain Prevailing Time" or "MPT" means Mountain Standard Time or Mountain Daylight Time, as applicable in Utah on the day in question.

"MW" means megawatt.

"MWh" means megawatt hour.

"Nameplate Capacity Rating" means the maximum installed instantaneous generation capacity of the completed Facility, expressed in MW (AC), when operated in compliance with the Generation Interconnection Agreement and consistent with the recommended power factor and operating parameters provided by the manufacturer of the Solar Panels and Inverters, as set forth in a notice from Seller to PacifiCorp delivered prior to the Commercial Operation Date and, if applicable, updated in a subsequent notice from Seller to PacifiCorp as required for Final Completion. The Nameplate Capacity Rating of the Facility shall be calculated as the sum of the manufacturer's output rating of the Inverters as indicated on the nameplate physically attached to such Inverters and shall not exceed 50.0 MW.

"NERC" means the North American Electric Reliability Corporation.

"Net Output" means all energy and capacity produced by the Facility, less station use and less transformation and transmission losses and other adjustments (e.g., Seller's load other than station use), if any. For purposes of calculating payment under this Agreement, Net Output of energy shall be the amount of energy flowing through the Point of Delivery.

"Network Resource" is defined in the Tariff.

"Network Service Provider" means PacifiCorp Transmission, as a provider of network service to PacifiCorp under the Tariff.

"Off-Peak Hours" or "LLH" means all hours ending 01:00:00 through 06:00:00 and hours ending 23:00:00 through 24:00:00, MPT, Monday through Saturday and hours ending 01:00:00 through 24:00:00, MPT, on Sundays and NERC designated holidays.

"On-Peak Hours" or "HLH" means all hours ending 07:00:00 through 22:00:00 MPT, Monday through Saturday, excluding NERC designated holidays.

"Output" means all energy produced by the Facility.

"Output Guarantee" is defined in Section 6.12.1.

"Output Shortfall" is defined in Section 6.12.2.

"PacifiCorp" is defined in the Recitals, and explicitly excludes PacifiCorp Transmission.

"PacifiCorp Indemnitees" is defined in Section 12.1.1.

"PacifiCorp Representatives" is defined in Section 6.13.

"PacifiCorp Transmission" means PacifiCorp, an Oregon corporation, acting in its interconnection or transmission function capacity.

"PacifiCorp's Cost to Cover" means the positive difference, if any, between (a) the sum of (i) the time weighted average of the Firm Market Price Index for each day for which the determination is being made, plus (ii) (A) the price of replacement Green Tags or (B) if, after using commercially reasonable efforts to do so, Buyer is unable to replace Green Tags, the Green Tag Price Component, minus (b) the Contract Price specified in Exhibit 5.1 in effect on such days, stated as an amount per MWh. If on a given day (or Contract Year in the case of calculating Output Shortfall) the difference between (a) minus (b) referenced above is zero or negative, then PacifiCorp's Cost to Cover shall be zero dollars (\$0), and Seller shall have no obligation to pay any amount to PacifiCorp on account of Section 6.12.2 or Section 11.2.1 with respect to such day (or Contract Year in the case of calculating Output Shortfall). For any days prior to the Commercial Operation Date, the Contract Price applicable in the first Contract Year shall be utilized for purposes of clause (b).

"Party" and "Parties" are defined in the Recitals.

"Permits" means the permits, licenses, approvals, certificates, entitlements and other authorizations issued by Governmental Authorities required for the construction, ownership and operation of the Facility and occupancy of the Premises, and all amendments, modifications, supplements, general conditions and addenda thereto.

"Planned Outage" means NERC Event Type PO, as set forth in attached Exhibit B, and specifically excludes any Maintenance Outage or Forced Outage.

"Point of Delivery" means the point of interconnection between the Facility and the System, as specified in the Generation Interconnection Agreement and as further described in Exhibit 9.2.

"Premises" means the real property on which the Facility is or will be located, as more fully described on Exhibit 6.1.

"Project Development Security" has the meaning given to that term in Section 8.1.1.

"Prudent Electrical Practices" means any of the practices, methods and acts engaged in or approved by a significant portion of the independent electric power generation industry for solar facilities of similar size and characteristics or any of the practices, methods or acts, which, in the exercise of reasonable judgment in the light of the facts known at the time a decision is made, could have been expected to accomplish the desired result at the lowest reasonable cost consistent with reliability, safety and expedition. Prudent Electrical Practices is not intended to be limited to the optimum practice, method or act to the exclusion of all others, but rather to be a spectrum of possible practices, methods or acts.

"PUHCA" means the Public Utility Holding Company Act of 2005.

"PURPA" means the Public Utility Regulatory Policies Act of 1978.

"QF" means "Qualifying Facility," as that term is defined in the FERC regulations (codified at 18 CFR Part 292) in effect on the Effective Date.

"Qualifying Institution" means the United States office of a commercial bank or trust company organized under the laws of the United States of America or a political subdivision thereof, or a foreign bank, having assets \$10,000,000,000 (net of reserves) and a credit rating on its long-term senior unsecured debt of at least "A" from S&P and "A2" from Moody's.

"Reporting Quarter" is defined in Section 6.10.1.

"Required Facility Documents" means the Permits and other authorizations, rights and agreements now or hereafter necessary for construction, operation, and maintenance of the Facility. Seller shall set forth all the Required Facility Documents in Exhibit 3.2.3.

"Required Percentage" means 90 percent.

"Requirements of Law" means any applicable and mandatory (but not merely advisory) federal, state and local law, statute, regulation, rule, action, order, code or ordinance enacted, adopted, issued or promulgated by any federal, state, local or other Governmental Authority or regulatory body (including those pertaining to electrical, building, zoning, environmental and occupational safety and health requirements).

"Rolling Period" means any two consecutive Contract Years occurring during the Term.

"RTO" means any entity (including, but not limited to an independent system operator) that becomes responsible as system operator for, or directs the operation of, the System.

"S&P" means Standard & Poor's Rating Group (a division of McGraw-Hill, Inc.).

"Schedule 38" means Rocky Mountain Power Electric Service Schedule No. 38 as attached in Exhibit 5.1, and as approved by the Commission.

"Scheduled Commercial Operation Date" means December 1, 2016.

"Seller" is defined in the Recitals.

"Seller Indemnitees" is defined in Section 12.1.2.

"Seller's Cost to Cover" means the positive difference, if any, between (a) the Contract Price per MWh specified in Exhibit 5.1, and (b) the net proceeds per MWh actually realized by Seller from the sale to a third party of Net Output and Green Tags not purchased by PacifiCorp as required hereunder. If on any given day the difference between (a) minus (b) referenced above is zero or negative, then Seller's Cost to Cover shall be zero dollars with respect to such day, and PacifiCorp shall have no obligation to pay any amount to Seller on account of Section 11.2.2. For any days prior to the Commercial Operation Date, the Contract Price applicable in the first Contract Year shall be utilized for purposes of clause (a).

"Seller Uncontrollable Minutes" means, for the Facility in any Contract Year, the total number of minutes during such Contract Year during which the Facility was unable to deliver Net Output to PacifiCorp (or during which PacifiCorp failed to accept such delivery) due to one or more of the following events, each as recorded by Seller's SCADA and indicated by Seller's electronic fault log: (a) an emergency or Force Majeure event; (b) to the extent not caused by Seller's actions, a curtailment in accordance with Section 4.4; (c) the System operating outside the voltage or frequency limits defined in the applicable operating manual for the Inverters installed at the Facility; (d) Planned Outages, but in no event exceeding 36 hours per Contract Year consistent with such operating manual; and (e) a default by PacifiCorp; provided, however, that if any of the events described above in items (a) through (e) occur simultaneously, then the relevant period of time shall only be counted once in order to prevent double counting. Seller Uncontrollable Minutes shall not include minutes when (i) the Facility or any portion thereof was unavailable solely due to Seller's non-conformance with the Generation Interconnection Agreement or (ii) the Facility or any portion thereof was paused or withdrawn from use by Seller for reasons other than those covered in this definition.

"Senior Lenders" means Lenders being granted senior security interests on the Facility or its assets, or Seller or its equity, other than Affiliates of Seller.

"Solar Array" means one or more Solar Panels connected to the same Inverter.

"Solar Panels" means the photovoltaic energy generating panels installed at the Facility as described in Exhibit 6.1.

"Solar Performance Modeling Program" means a commercially available computer modeling program that is generally accepted in the solar energy industry capable of modeling the Expected Energy and other similar outputs. Solar Performance Modeling Program includes, but is not limited to, the PVSYST program. If Seller selects a Solar Performance Modeling Program that PacifiCorp does not have access too, Seller, at its cost, shall provide PacifiCorp access to the Solar Performance Modeling Program in order for PacifiCorp to fully analyze all modeling provided by Seller under this Agreement.

"Start-Up Testing" means the start-up tests for the Facility as set forth in Exhibit C.

"Step-In Rights" is defined in Section 8.4.2.

"System" means the electric transmission substation and transmission or distribution facilities owned, operated or maintained by Network Service Provider or Interconnection Provider, which shall include, after construction and installation of the Facility, the circuit reinforcements, extensions, and associated terminal facility reinforcements or additions required to interconnect the Facility, all as set forth in the Generation Interconnection Agreement.

"Tariff" means the PacifiCorp FERC Electric Tariff Fifth Revised Volume No. 11 Pro Forma Open Access Transmission Tariff, as revised from time to time.

"Tax Credits" means any state, local and/or federal production tax credit, tax deduction, and/or investment tax credit specific to the production of renewable energy and/or investments in renewable energy facilities.

"Technical Expert" is defined in Section 24.2.2.

"Term" is defined in Section 2.1.

"Test Energy" means any Net Output produced during periods prior to the Commercial Operation Date, and all associated Green Tags and Capacity Rights.

"WECC" means the Western Electricity Coordinating Council.

"WREGIS" means the Western Renewable Energy Generation Information System.

"WREGIS Certificate" or "Certificate" means "Certificate" as defined by the WREGIS Operating Rules.

"WREGIS Operating Rules" means the operating rules and requirements adopted by WREGIS, including the WREGIS Terms of Use.

1.2 Rules of Interpretation.

1.2.1 General. Unless otherwise required by the context in which any term appears, (a) the singular includes the plural and vice versa; (b) references to "Articles," "Sections," "Schedules," "Annexes," "Appendices" or "Exhibits" are to articles, sections, schedules, annexes, appendices or exhibits hereof; (c) all references to a particular entity or an electricity market price index include a reference to such entity's or index's successors; (d) "herein," "hereof" and "hereunder" refer to this Agreement as a whole; (e) all accounting terms not specifically defined herein shall be construed in accordance with generally accepted accounting principles, consistently applied; (f) the masculine includes the feminine and neuter and vice versa; (g) "including" means "including, without limitation" or "including, but not limited to"; (h) all references to a particular law or statute mean that law or statute as amended from time to time; (i) all references to energy or capacity are to be interpreted as utilizing alternating current, unless expressly stated otherwise; and (j) the word "or" is not necessarily exclusive. Reference to "days" shall be calendar days, unless expressly stated otherwise herein.

1.2.2 Terms Not to be Construed For or Against Either Party. Each term hereof shall be construed simply according to its fair meaning and not strictly for or against either Party. The Parties have jointly prepared this Agreement, and no term hereof shall be construed against a Party on the ground that the Party is the author of that provision.

1.2.3 Headings. The headings used for the sections and articles hereof are for convenience and reference purposes only and shall in no way affect the meaning or interpretation of the provisions hereof.

1.2.4 Examples. Example calculations and other Examples set forth herein are for purposes of illustration only and are not intended to constitute a representation, warranty or covenant concerning the example itself or the matters assumed for purposes of such Example. If there is a conflict between an Example and the text hereof, the text shall control.

1.2.5 Interpretation with FERC Orders. Each Party conducts and shall conduct its operations in a manner intended to comply with FERC Order No. 2004, Standards of Conduct for Transmission Providers, requiring the separation of its transmission and merchant functions. Moreover, the Parties acknowledge that Interconnection Provider's transmission function offers transmission service on its System in a manner intended to comply with FERC policies and requirements relating to the provision of open-access transmission service. The Parties recognize that Seller will enter into the Generation Interconnection Agreement with the Interconnection Provider.

(a) The Parties acknowledge and agree that the Generation Interconnection Agreement shall be a separate and free standing contract and that the terms hereof are not binding upon the Interconnection Provider.

(b) Notwithstanding any other provision in this Agreement, nothing in the Generation Interconnection Agreement, nor any other agreement between Seller on the one hand and Network Service Provider or Interconnection Provider on the other hand, nor any alleged event of default thereunder, shall alter or modify the Parties' rights, duties, and obligation hereunder. This Agreement shall not be construed to create any rights between Seller and the Interconnection Provider or between Seller and the Network Service Provider.

(c) Seller expressly recognizes that, for purposes hereof, the Interconnection Provider and Network Service Provider each shall be deemed to be a separate entity and separate contracting party from PacifiCorp whether or not the Generation Interconnection Agreement is entered into with Interconnection Provider or an Affiliate thereof. Seller acknowledges that PacifiCorp, acting in its merchant capacity function as purchaser hereunder, has no responsibility for or control over Interconnection Provider or Network Service Provider, and is not liable for any breach of agreement or duty by Interconnection Provider or Network Service Provider.

SECTION 2

TERM; FACILITY DEVELOPMENT

1.3 Term; Inter-jurisdictional Cost Allocation. This Agreement shall become effective when it is executed and delivered by both Parties and has been approved by the Commission (the "Effective Date"), and, unless earlier terminated as provided herein, shall remain in effect until the twentieth (20th) anniversary of the Commercial Operation Date (the "Term"). In the event that the Commission order approving this Agreement requires any change in this Agreement or imposes any requirement or condition not anticipated by the Parties that may reasonably be expected to be materially adverse to either Party, the Party materially and adversely impacted by such change, requirement or condition may terminate this Agreement by providing the other Party notice within thirty (30) days of the entry of the Commission's order.

1.4 Adverse Order. For purposes of inter-jurisdictional cost allocation, this Agreement constitutes a “New QF Contract” under the PacifiCorp Inter-Jurisdictional Cost Allocation 2010 Protocol and, as such, the costs of those QF provisions are allocated as a system resource unless any portion of those costs exceeds the cost PacifiCorp would have otherwise incurred acquiring comparable resources. In that event, the 2010 Protocol assigns those excess costs on a situs basis to the State of Utah. The rates, terms and conditions in this Agreement are in accordance with the rates, terms and conditions approved by the Commission for purchases from qualifying facilities. In addition, for the purposes of inter-jurisdictional cost allocation, PacifiCorp represents that the costs of this Agreement do not exceed the costs PacifiCorp would have otherwise incurred acquiring resources in the market that are defined as “Comparable Resources” in Appendix A to the Inter-Jurisdictional Cost Allocation 2010 Protocol.

1.5 Milestones. Time is of the essence in the performance hereof, and Seller's completion of the Facility and delivery of Net Output and Green Tags by the Scheduled Commercial Operation Date is critically important. Therefore, Seller shall achieve the following milestones at the times indicated:

(a) On or before [REDACTED] Seller shall provide PacifiCorp with a fully executed Generation Interconnection Agreement;

(b) On or before the 30th day following the Effective Date, Seller shall post 100% of the Project Development Security in the amount described in Section 8.1;

(c) By the Commercial Operation Date, Seller shall provide Default Security required under Section 8.2;

(d) Seller shall provide PacifiCorp with documentation showing that Seller has obtained retail electric service for the Facility prior to the Commercial Operation Date;

(e) Seller shall cause the Facility to achieve Commercial Operation on or before the Guaranteed Commercial Operation Date; and

(f) If Commercial Operation of the Facility is achieved based on less than 100 percent of the Expected Nameplate Capacity Rating, then Seller shall cause the Facility to achieve Final Completion on or before the 120th day after the Commercial Operation Date and if Final Completion has not been achieved by such date then the Nameplate Capacity Rating of the Facility shall be deemed to be the sum of the manufacturer's output rating of the Inverters as indicated on the nameplate physically attached to such Inverters as of the date that is 120 days from the Commercial Operation Date; provided, however, that the date for achieving each of the foregoing milestones shall be extended on a day for day basis for any delay due solely to (i) PacifiCorp's delay in taking, or failure to take, any action required of it hereunder in breach of this Agreement, or (ii) an event of Force Majeure.

1.6 Project Construction and Delay Damages.

(a) On or before the later of: (i) the Facility Financing Date or (ii) excavation of the first foundation for the photovoltaic panels, Seller shall provide to PacifiCorp a certificate from a Licensed Professional Engineer confirming that the Required Facility

Documents identified on Exhibit 3.2.3 as being required to be obtained prior to the issuance of the notice to proceed from Seller to the engineering, procurement and construction contractor for the Facility have been obtained by Seller.

(b) If Commercial Operation is not achieved on or before the Scheduled Commercial Operation Date, Seller shall pay to PacifiCorp Delay Damages from and after the Scheduled Commercial Operation Date up to, but not including, the date that the Facility achieves Commercial Operation.

(c) If the Facility does not achieve Commercial Operation by the Guaranteed Commercial Operation Date, PacifiCorp may terminate this Agreement pursuant to Section 11.

(d) After the date of Final Completion, any partially completed Solar Array that increases the Nameplate Capacity Rating shall not be part of the Facility, and Seller shall not undertake to add those Solar Array or output from such Solar Array to the Facility without the prior written consent of PacifiCorp. Any output of such Solar Array or Capacity Rights associated with such output shall be treated as Net Output above the Maximum Delivery Rate and is subject to Section 6.8.

1.7 Damages Calculation. Each Party agrees and acknowledges that (a) the damages that PacifiCorp would incur due to Seller's delay in achieving Commercial Operation would be difficult or impossible to predict with certainty, and (b) it is impractical and difficult to assess actual damages in the circumstances stated, and therefore the Delay Damages as agreed to by the Parties and set forth herein are a fair and reasonable calculation of such damages. The Parties agree that Delay Damages shall be PacifiCorp's exclusive remedy for a delay in achieving Commercial Operation and believe that Delay Damages fairly represent actual damages. Subject to the foregoing sentence, this Section 2.5 shall not limit the amount of damages payable to PacifiCorp if this Agreement is terminated as a result of Seller's failure to achieve Commercial Operation by the Guaranteed Commercial Operation Date. Any such termination damages shall be determined in accordance with Section 11.5.

1.8 Damages Invoicing. By the 10th day following the end of the calendar month in which Delay Damages begin to accrue and continuing on the 10th day of each calendar month during the period in which Delay Damages accrue (and the following months, if applicable), PacifiCorp shall deliver to Seller an invoice showing PacifiCorp's computation of such damages and any amount due PacifiCorp in respect thereof for the preceding calendar month. No later than 10 days after receiving such an invoice and subject to Sections 10.3 and 10.4, Seller shall pay to PacifiCorp, by wire transfer of immediately available funds to an account specified in writing by PacifiCorp or by any other means agreed to by the Parties in writing from time to time, the amount set forth as due in such invoice.

1.9 PacifiCorp's Right to Monitor. During the Term, Seller shall permit PacifiCorp and its advisors and consultants to:

(a) Review and discuss with Seller and its advisors and consultants monthly status reports on the progress of the acquisition, design, financing, engineering,

construction and installation of the Facility. Between the Effective Date and 30 days following the date of Final Completion, Seller shall, on or before the 10th day of each calendar month, provide PacifiCorp with a brief monthly status report for the preceding month.

(b) Monitor the status of the acquisition, land leasing, design, financing, engineering, construction and installation of the Facility and the performance of the contractors constructing the Facility.

(c) Monitor and receive monthly updates from Seller concerning (i) the progress of Seller's negotiation and execution of contracts for the acquisition, design, financing, engineering, construction and installation of the Facility, Premises, major equipment, and warranties, and (ii) the contractors' performance and achievement of contract deliverables and all performance and other tests required to achieve Commercial Operation or contemplated by the warranty agreements between Seller and a manufacturer of the Facility's Solar Panels and Inverters and any other material items of Facility equipment that require testing for warranty agreements to be effective. Seller shall provide PacifiCorp with at least two Business Days prior notice of each such test, with the understanding that if the performance of such test is dependent on the presence of sufficient solar exposure or other variables beyond the control of Seller, the date of such test may be postponed if, on the date specified in the related notice, there is insufficient solar exposure or other circumstances beyond the control of Seller that prevent the performance of such test on the scheduled date. Seller does not herein grant PacifiCorp the right to review, comment on or approve of the terms or conditions of any contract or negotiation between Seller and a third party, the terms and conditions of each such contract or negotiation being confidential and to be determined by Seller in its sole discretion. Conversely, nothing in this Agreement shall be construed to require PacifiCorp to review, comment on, or approve of any contract between Seller and a third party.

(d) Witness initial performance tests and other tests and review the results thereof; with Seller to make best efforts to provide PacifiCorp five Business Days' advance notice of each such major test.

(e) Perform such examinations, inspections, and quality surveillance as, in PacifiCorp's reasonable judgment, are appropriate and advisable to determine that the Facility has been properly commissioned and Commercial Operation and Final Completion have been achieved.

With respect to PacifiCorp's right to monitor under this Section 2.7, (i) PacifiCorp is under no obligation to exercise any of these monitoring rights, (ii) such monitoring shall occur subject to reasonable rules developed by Seller regarding Facility construction, access, health, safety, and environmental requirements, and (iii) PacifiCorp shall have no liability to Seller for failing to advise it of any condition, damages, circumstances, infraction, fact, act, omission or disclosure discovered or not discovered by PacifiCorp with respect to the Facility or any contractor. Any review or monitoring of the Facility conducted by PacifiCorp hereunder shall be performed in a manner that does not impede, hinder, postpone, or delay Seller or its contractors in their performance of the engineering, construction, design or testing of the Facility. PacifiCorp shall maintain one or more designated representatives for purposes of the monitoring activities contemplated in this Section 2.7, which representatives shall have authority to act for PacifiCorp

in all technical matters under this Section 2.7 as authorized by PacifiCorp but not to amend or modify any provision hereof. PacifiCorp's initial representatives and their contact information are listed in Exhibit 2.7. PacifiCorp may, by written notice to Seller, change its representatives or their contact information.

1.10 Tax Credits. Seller shall elect to claim ITCs with respect to the Facility. In the event Seller changes its position and elects not to claim ITCs with respect to the Facility, Seller shall notify PacifiCorp that Seller has elected not to claim ITCs, as applicable, within 30 days following the date that Seller (or Seller's Affiliate, on a consolidated basis) files its first tax return after the Commercial Operation Date. Seller shall bear all risks, financial and otherwise throughout the Term, associated with Seller's or the Facility's eligibility to receive ITCs or other Tax Credits, or to qualify for accelerated depreciation for Seller's accounting, reporting or tax purposes. The obligations of the Parties hereunder, including those obligations set forth herein regarding the purchase and price for and Seller's obligation to deliver Net Output, shall be effective regardless of whether the sale of Output or Net Output from the Facility is eligible for, or receives, ITCs, or other Tax Credits during the Term.

SECTION 3 REPRESENTATIONS AND WARRANTIES

1.11 Mutual Representations and Warranties. Each Party represents, covenants, and warrants to the other that:

1.11.1 Organization. It is duly organized and validly existing under the laws of the state of its organization.

1.11.2 Authority. It has the requisite power and authority to enter hereinto and to perform according to the terms hereof.

1.11.3 Corporate Actions. It has taken all corporate actions required to be taken by it to authorize the execution, delivery and performance hereof and the consummation of the transactions contemplated hereby.

1.11.4 No Contravention. The execution and delivery hereof does not contravene any provision of, or constitute a default under, any indenture, mortgage, security instrument or undertaking, or other material agreement to which it is a party or by which it is bound, or any valid order of any court, or any regulatory agency or other Governmental Authority having authority to which it is subject.

1.11.5 Valid and Enforceable Agreement. This Agreement is a valid and legally binding obligation of it, enforceable against it in accordance with its terms, except as the enforceability hereof may be limited by general principles of equity or bankruptcy, insolvency, bank moratorium or similar laws affecting creditors' rights generally and laws restricting the availability of equitable remedies.

1.11.6 Litigation. No litigation, arbitration, investigation or other proceeding is pending or, to the best of either Party's knowledge, threatened in writing against either Party or its members, with respect hereto and the transactions contemplated hereunder. No other

investigation or proceeding is pending or threatened in writing against a Party, its members, or any Affiliate, the effect of which would materially and adversely affect the Party's performance of its obligations hereunder.

1.12 Seller's Further Representations and Warranties. Seller further represents, covenants, and warrants to PacifiCorp that:

1.12.1 Authority. Seller (a) has (or will have prior to the Commercial Operation Date) all required regulatory authority to make wholesale sales from the Facility; (b) has the power and authority to own and operate the Facility and be present upon the Premises for the Term; and (c) is duly qualified and in good standing under the laws of each jurisdiction where its ownership, lease or operation of property or the conduct of its business requires such qualification.

1.12.2 No Contravention. The execution, delivery, performance and observance by Seller of its obligations hereunder do not and will not:

(a) contravene, conflict with or violate any provision of any material Requirements of Law presently in effect having applicability to either Seller or any of Seller's members;

(b) require the consent or approval of or material filing or registration with any Governmental Authority or other person other than such consents and approvals which are (i) set forth in Exhibit 3.2.3 or (ii) required in connection with the construction or operation of the Facility and expected to be obtained in due course; or

(c) result in a breach of or constitute a default under any provision of any security issued by any of Seller's members or managers, the effect of which would materially and adversely affect Seller's performance of, or ability to perform, its obligations hereunder, or any material agreement, instrument or undertaking to which either Seller's members or any Affiliates of Seller's members is a party or by which the property of any of Seller's members or any Affiliates of Seller's members is bound, the effect of which would materially and adversely affect Seller's performance of, or ability to perform, its obligations hereunder.

1.12.3 Required Facility Documents. To the best of Seller's knowledge, all Required Facility Documents are listed on Exhibit 3.2.3. Pursuant to the Required Facility Documents, Seller holds as of the Effective Date, or will hold by the Commercial Operation Date (or such other later date as may be specified under Requirements of Law), and will maintain for the Term all Required Facility Documents (including, but not limited to, all material authorizations, rights and entitlements) necessary to construct, own and operate the Facility and to deliver Net Output to PacifiCorp in accordance with this Agreement. The anticipated use of the Facility complies with all applicable restrictive covenants affecting the Premises. Following the Commercial Operation Date, Seller shall notify PacifiCorp of any additional material consent or approval that is required for the operation and maintenance of the Facility promptly after Seller makes any such determination.

1.12.4 Delivery of Energy. On or before the Commercial Operation Date, Seller shall hold rights sufficient to enable Seller to deliver Net Output at the Nameplate

Capacity Rating from the Facility to the Point of Delivery pursuant to this Agreement throughout the Term.

1.12.5 Control of Premises. Seller has all legal rights necessary for the Seller to enter upon and occupy the Premises for the purpose of constructing, operating and maintaining the Facility for the Term. All leases of real property required for the operation of the Facility or the performance of any obligations of Seller hereunder are set forth and accurately described in Exhibit 3.2.5. Seller shall maintain all leases or other land grants necessary for the construction, operation and maintenance of the Facility as valid for the Term. Upon request by PacifiCorp, Seller shall provide copies of the memoranda of lease recorded in connection with the development of the Facility to PacifiCorp.

3.2.6 Undertaking of Agreement; Professionals and Experts. Seller has engaged those professional or other experts it believes necessary to understand its rights and obligations pursuant to this Agreement. All professionals or experts including, but not limited to, engineers, attorneys or accountants, that Seller may have consulted or relied on in undertaking the transactions contemplated by this Agreement have been solely those of Seller.

3.2.7 Verification. All information relating to the Facility, its operation and output provided to Buyer and contained in this Agreement has been verified by Seller and, to the best of Seller's knowledge, is true and accurate.

1.13 No Other Representations or Warranties. Each Party acknowledges that it has entered hereinto in reliance upon only the representations and warranties set forth in this Agreement, and that no other representations or warranties have been made by the other Party with respect to the subject matter hereof.

1.14 Continuing Nature of Representations and Warranties; Notice. The representations and warranties set forth in this section are made as of the Effective Date and deemed repeated as of the Commercial Operation Date. If at any time during the Term, the Seller obtains actual knowledge of any event or information that would have caused any of the representations and warranties in Section 3 to be materially untrue or misleading at the time given, such Party shall provide the other Party with written notice of the event or information, the representations and warranties affected, and the action, if any, which such Party intends to take to make the representations and warranties true and correct. If at any time the Seller obtains actual knowledge that the representations and warranties in Sections 3.2.1, 3.2.2(a), 3.2.3, 3.2.4 or 3.2.5 are not true, Seller shall provide written notice to PacifiCorp. The notice required pursuant to this section shall be given as soon as practicable after the occurrence of each such event.

SECTION 4 DELIVERIES OF NET OUTPUT AND GREEN TAGS

1.15 Purchase and Sale. Except as otherwise expressly provided herein, commencing on the Commercial Operation Date and continuing through the Term, Seller shall sell and make available to PacifiCorp, and PacifiCorp shall purchase and receive, (a) the entire Net Output

from the Facility at the Point of Delivery, and (b) all Green Tags associated with Net Output or otherwise resulting from the generation of energy by the Facility. PacifiCorp shall be under no obligation to make any purchase hereunder other than Net Output and Green Tags, as described above. Except for damages provided in Section 11.2.2(b), PacifiCorp shall not be obligated to purchase, receive or pay for Net Output (or Green Tags associated with Net Output) that is not delivered to the Point of Delivery. In addition, during the period between the Effective Date and the Commercial Operation Date, Seller shall sell and make available to PacifiCorp, and PacifiCorp shall purchase and receive, all Net Output and associated Green Tags from the Facility as Test Energy at the price specified in Section 5.1.1.

1.16 No Sales to Third Parties. During the Term, Seller shall not sell any Net Output, energy, Green Tags or Capacity Rights from the Facility to any party other than PacifiCorp; provided, however, that this restriction shall not apply during periods when PacifiCorp is in default hereof because it has failed to accept or purchase that Net Output or Green Tags as required hereunder.

1.17 Title and Risk of Loss of Net Output. Seller shall deliver Net Output and associated Green Tags to the Point of Delivery and Capacity Rights free and clear of all liens, claims and encumbrances. Title to and risk of loss of all Net Output shall transfer from Seller to PacifiCorp upon its delivery to PacifiCorp at the Point of Delivery. Seller shall be deemed to be in exclusive control of, and responsible for, any damage or injury caused by, all Output up to and at the Point of Delivery. PacifiCorp shall be deemed to be in exclusive control of, and responsible for, any damages or injury caused by, Net Output after the Point of Delivery.

1.18



1.19 PacifiCorp as Merchant. Seller acknowledges that PacifiCorp, acting in its merchant capacity function as purchaser under this Agreement, has no responsibility for or control over PacifiCorp Transmission or any successor Network Service Provider or Interconnection Provider.

1.20 Transfer of Title to Green Tags; Documentation of Green Tags Transfers.

1.20.1 Title to the Green Tags shall pass from Seller to PacifiCorp immediately upon the generation of the Output at the Facility that gives rise to such Green Tags. The Parties shall execute all additional documents and instruments reasonably requested by PacifiCorp in order to further document the transfer of the Green Tags to PacifiCorp or its designees. Without limiting the generality of the foregoing, Seller shall, on or before the 10th day of each month, deliver to PacifiCorp a Green Tags Attestation and Bill of Sale in the form attached as Exhibit 4.6(1) for all Green Tags delivered to PacifiCorp hereunder in the preceding month, along with any attestation that is then-current with the Center for Resource Solution's Green-e program. Seller, at its own cost and expense, shall register with, pay all fees required by, and comply with, all reporting and other requirements of WREGIS relating to the Facility or Green Tags. Seller shall ensure that the Facility will participate in and comply with, during the Term, all aspects of WREGIS. Seller shall, at its sole expense, use WREGIS as required pursuant to the WREGIS Operating Rules to effectuate the transfer of WREGIS Certificates to PacifiCorp, and transfer such WREGIS Certificates to PacifiCorp, in accordance with WREGIS reporting protocols and WREGIS Operating Rules, and within fifteen (15) days of WREGIS Certificate creation in WREGIS. Seller may either elect to enter into a Qualified Reporting Entity Services Agreement with PacifiCorp in a form similar to that in Exhibit 4.6(2) or elect to act as its own WREGIS-defined Qualified Reporting Entity. PacifiCorp shall be entitled to a refund of the Green Tag Price Component of Green Tags associated with any Output for which WREGIS Certificates are not delivered, and shall not transfer the affected Green Tags back to Seller.

1.20.2 Seller shall promptly give PacifiCorp copies of all documentation it submits to WREGIS. Further, in the event of the promulgation of a scheme involving Green Tags administered by CAMD, upon notification by CAMD that any transfers contemplated by this Agreement will not be recorded, the Parties shall promptly cooperate in taking all reasonable actions necessary so that such transfers can be recorded. Seller shall not report under Section 1605(b) of the Energy Policy Act of 1992 or under any applicable program that any of the Green Tags purchased by PacifiCorp hereunder belong to any person other than PacifiCorp. Without limiting the generality of PacifiCorp's ownership of the Green Tag Reporting Rights, PacifiCorp may report under such program that such Environmental Attributes purchased hereunder belong to it. Each Party shall promptly give the other Party copies of all documents it submits to the CAMD to effectuate any transfers. Seller shall at its expense cause the Facility to maintain its registration in good standing with the Center for Resource Solution's Green-e program throughout the Term. Seller shall reasonably cooperate in any registration by PacifiCorp of the Facility in the renewable portfolio standard or equivalent program in all such further states and programs in which PacifiCorp may wish to register or maintained registered the Facility by providing copies of all such information as PacifiCorp reasonably requires for such registration.

1.21 Capacity Rights.

1.21.1 Purchase and Sale of Capacity Rights. For and in consideration of PacifiCorp's agreement to purchase from Seller the Facility's Net Output and Green Tags on the terms and conditions set forth herein, Seller transfers to PacifiCorp, and PacifiCorp accepts from Seller, any right, title, and interest that Seller may have in and to Capacity Rights, if any, existing during the Term.

1.21.2 Representation Regarding Ownership of Capacity Rights. Seller represents that it has not sold, and covenants that during the Term it will not sell or attempt to sell to any other person or entity the Capacity Rights, if any. During the Term, Seller shall not report to any person or entity that the Capacity Rights, if any, belong to anyone other than PacifiCorp. PacifiCorp may at its own risk and expense report to any person or entity that Capacity Rights exclusively belong to it.

1.21.3 Further Assurances. At PacifiCorp's request, the Parties shall execute such documents and instruments as may be reasonably required to effect recognition and transfer of the Net Output or Capacity Rights, if any, to PacifiCorp.

SECTION 5 CONTRACT PRICE; COSTS

1.22 Contract Price; Includes Green Tags and Capacity Rights. PacifiCorp shall pay Seller the prices stated below for all deliveries of Net Output, and Capacity Rights, up to the Maximum Delivery Rate. The Contract Price provided for in Section 5.1.1 and the price for Test Energy provided for in Section 5.1.1 include the consideration to be paid by PacifiCorp to Seller for all Net Output, Green Tags, Capacity Rights and Test Energy, respectively, and Seller shall not be entitled to any compensation over and above the Contract Price or the Test Energy price, as the case may be, for the Green Tags or Capacity Rights associated therewith.

1.22.1 Test Energy and Net Output Before Later of Commercial Operation Date and Scheduled Commercial Operation Date. Between the Effective Date and the later to occur of the (i) Commercial Operation Date or (ii) the Scheduled Commercial Operation Date, Seller shall sell and deliver to PacifiCorp all Test Energy and Net Output. PacifiCorp shall pay Seller for such Test Energy and Net Output delivered at the Point of Delivery, [REDACTED]

[REDACTED] provided, however, that Seller's right to receive payment for such Test Energy and Net Output is subject to PacifiCorp's right of offset under Section 10.2 for, among other things, payment by Seller of any Delay Damages owed to PacifiCorp by Seller pursuant to Section 2.4.

1.22.2 Net Output After The Later of Commercial Operation Date and Scheduled Commercial Operation Date. For the period beginning on the later of (i) the Commercial Operation Date or (ii) the Scheduled Commercial Operation Date and thereafter during the Term, PacifiCorp shall pay to Seller the Contract Price per MWh of Net Output delivered to the Point of Delivery, as specified in Exhibit 5.1.

1.23 Costs and Charges. Seller shall be responsible for paying or satisfying when due all costs or charges imposed in connection with the scheduling and delivery of Net Output up to-and at the Point of Delivery, including transmission costs, transmission service, and

transmission line losses, and any operation and maintenance charges imposed by Interconnection Provider and Network Service Provider for the Interconnection Facilities. PacifiCorp shall be responsible for all costs or charges, if any, imposed in connection with the delivery of Net Output at and from the Point of Delivery, including transmission costs and transmission line losses and imbalance charges or penalties. Without limiting the generality of the foregoing, Seller, in accordance with the Generation Interconnection Agreement, shall bear all costs associated with the modifications to Interconnection Facilities or the System (including system upgrades) caused by or related to (a) the interconnection of the Facility with the System and (b) any increase in generating capacity of the Facility.

1.24 Station Service. Seller shall be responsible for arranging and obtaining, at its sole risk and expense, any station service required by the Facility that is not provided by the Facility itself.

1.25 Taxes. Seller shall pay or cause to be paid when due, or reimburse PacifiCorp for, all existing and any new sales, use, excise, severance, ad valorem, and any other similar taxes, imposed or levied by any Governmental Authority on the Net Output, Capacity Rights or Green Tags up to and including, but not beyond, the Point of Delivery, regardless of whether such taxes are imposed on PacifiCorp or Seller under Requirements of Law. PacifiCorp shall pay or cause to be paid when due all such taxes imposed or levied by any Governmental Authority on the Net Output, Capacity Rights or Green Tags (if owned by PacifiCorp as provided in Section 4.6) beyond the Point of Delivery, regardless of whether such taxes are imposed on PacifiCorp or Seller under Requirements of Law. The Contract Price shall not be adjusted on the basis of any action of any Governmental Authority with respect to changes to or revocations of sales and use tax benefits, rebates, exception or give back. In the event any taxes are imposed on a Party for which the other Party is responsible hereunder, the Party on which the taxes are imposed shall promptly provide the other Party notice thereof and such other information as such Party may reasonably request with respect to any such taxes. PacifiCorp and Seller agree that all Net Output, Green Tags and Capacity Rights are being purchased hereunder by PacifiCorp for resale. Promptly following the request therefor by Seller, PacifiCorp shall issue a property completed certificate of exemption indicating that the Net Output, Green Tags and Capacity Rights are exempt from sales and use taxes since such items are being purchased for resale.

1.26 Costs of Ownership and Operation. Without limiting the generality of any other provision hereof and subject to Section 5.4, Seller shall be solely responsible for paying when due (a) all costs of owning and operating the Facility in compliance with existing and future Requirements of Law and the terms and conditions hereof, and (b) all taxes and charges (however characterized) now existing or hereinafter imposed on or with respect to the Facility, its operation, or on or with respect to emissions or other environmental impacts of the Facility, including any such tax or charge (however characterized) to the extent payable by a generator of such energy or environmental attributes.

1.27 Rates Not Subject to Review. The rates for service specified herein shall remain in effect until expiration of the Term, and shall not be subject to change for any reason, including regulatory review, absent agreement of the Parties. Neither Party shall petition FERC pursuant to the provisions of Sections 205 or 206 of the Federal Power Act (16 U.S.C. § 792 et seq.) to amend such prices or terms, or support a petition by any other person seeking to amend such

prices or terms, absent the agreement in writing of the other Party. Further, absent the agreement in writing by both Parties, the standard of review for changes hereto proposed by a Party, a non-party or the FERC acting sua sponte shall be the "public interest" application of the "just and reasonable" standard of review set forth in United Gas Pipe Line Co. v. Mobile Gas Service Corp., 350 U.S. 332 (1956) and Federal Power Commission v. Sierra Pacific Power Co., 350 U.S. 348 (1956) and clarified by Morgan Stanley Capital Group. Inc. v. Public Util. Dist. No. 1 of Snohomish, 554 U.S. 527, 128 S. Ct. 2733 (2008).

SECTION 6 OPERATION AND CONTROL

1.28 As-Built Supplement. Within 90 days of completion of construction of the Facility, Seller shall provide PacifiCorp the As-built Supplement. The As-built Supplement shall be deemed effective and shall be added to Exhibit 6.1 when it has been reviewed and approved by PacifiCorp, which approval shall not be unreasonably withheld or delayed. If the proposed As-built Supplement does not accurately describe the Facility as actually built or is otherwise defective as to form in any material respect, PacifiCorp may within 15 days after receiving the proposed As-built Supplement give Seller a notice describing what PacifiCorp wishes to correct. If PacifiCorp does not give Seller such a notice within the 15 day period, the As-built Supplement shall be deemed approved. If PacifiCorp provides such a timely notice requiring corrections, Seller shall in good faith cooperate with PacifiCorp to revise the As-built Supplement to address PacifiCorp's concerns. Notwithstanding the foregoing, PacifiCorp shall have no right to require Seller to relocate, modify or otherwise change in any respect any aspect of the Facility as actually built.

1.29 Standard of Facility Operation.

1.29.1 General. At Seller's sole cost and expense, Seller shall build, operate, maintain and repair the Facility and the Interconnection Facilities in accordance with (a) the applicable and mandatory standards, criteria and formal guidelines of FERC, NERC, any RTO, and any other Electric System Authority and any successors to the functions thereof; (b) the Permits and Required Facility Documents; (c) the Generation Interconnection Agreement; (d) all Requirements of Law; (e) the requirements hereof; and (f) Prudent Electrical Practices. Seller acknowledges that it shall have no claims hereunder against PacifiCorp with respect to any requirements imposed by or damages caused by (or allegedly caused by) the Interconnection Provider or Network Service Provider. Seller will have no claims against PacifiCorp under this Agreement with respect to the provision of station service.

1.29.2 Qualified Operator. From and after the Commercial Operation Date, Seller or an Affiliate of Seller shall itself operate the Facility or cause the Facility to be operated by an entity that has at least two years of experience in operation of solar energy facilities of comparable size to the Facility. Seller shall provide PacifiCorp 30 days prior written notice of any change in operator.

1.29.3 Fines and Penalties.

(a) Without limiting a Party's rights under Section 6.2.3(b), each Party shall pay all fines and penalties incurred by such Party on account of noncompliance by such Party with Requirements of Law in respect to this Agreement, except where such fines and penalties are being contested in good faith through appropriate proceedings.

(b) If fines, penalties, or legal costs are assessed against or incurred by either Party (the "Indemnified Party") on account of any action by any Governmental Authority due to noncompliance by the other Party (the "Indemnifying Party") with any Requirements of Law or the provisions hereof, or if the performance of the Indemnifying Party is delayed or stopped by order of any Governmental Authority due to the Indemnifying Party's noncompliance with any Requirements of Law, the Indemnifying Party shall indemnify and hold harmless the Indemnified Party against any and all losses, liabilities, damages, and claims suffered or incurred by the Indemnified Party as a result thereof. Without limiting the generality of the foregoing, the Indemnifying Party shall reimburse the Indemnified Party for all fees, damages, or penalties imposed on the Indemnified Party by any Governmental Authority, other person or to other utilities for violations to the extent caused by a default by the Indemnifying Party or a failure of performance by the Indemnifying Party hereunder.

1.30 Interconnection. Seller shall be responsible for the costs and expenses associated with interconnection of the Facility at its Nameplate Capacity Rating at the Point of Delivery. Seller shall have no claims hereunder against PacifiCorp, acting in its merchant function capacity, with respect to any requirements imposed by or damages caused by (or allegedly caused by) acts or omissions of the Network Service Provider or Interconnection Provider, in connection with the Generation Interconnection Agreement or otherwise.

1.31 Coordination with System. Seller shall be responsible for the coordination and synchronization of the Facility and the Interconnection Facilities with the System.

1.32 Outages.

1.32.1 Planned Outages. Except as otherwise provided herein, Seller shall not schedule a Planned Outage during day light hours (sun-up to sunset) during any portion of the months of November, December, January, February, June, July, and August, except to the extent a Planned Outage is reasonably required to enable a vendor to satisfy a guarantee requirement. Seller shall provide PacifiCorp with an annual forecast of Planned Outages for each Contract Year at least one month, but no more than three months, before the first day of that Contract Year, and shall promptly update such schedule, or otherwise change it only, to the extent that Seller is reasonably required to change it in order to comply with Prudent Electrical Practices. Seller shall not schedule any maintenance of Interconnection Facilities during such months, without the prior written approval of PacifiCorp, which approval shall not be unreasonably withheld or delayed.

1.32.2 Maintenance Outages. If Seller reasonably determines that it is necessary to schedule a Maintenance Outage, Seller shall notify PacifiCorp of the proposed Maintenance Outage as soon as practicable but in any event at least five days before the outage

begins (or such shorter period to which PacifiCorp may reasonably consent in light of then-existing solar exposure conditions). Upon such notice, the Parties shall plan the Maintenance Outage to mutually accommodate the reasonable requirements of Seller and the service obligations of PacifiCorp; provided, however, that Seller shall take all reasonable measures consistent with Prudent Electrical Practices to not schedule any Maintenance Outage during the day light hours of the following periods: November, December, January, February, June 15 through June 30, July, August, and September 1 through September 15. Notice of a proposed Maintenance Outage shall include the expected start date and time of the outage, the amount of generation capacity of the Facility that will not be available, and the expected completion date and time of the outage. Seller shall give PacifiCorp notice of the Maintenance Outage as soon as practicable after Seller determines that the Maintenance Outage is necessary. PacifiCorp shall promptly respond to such notice and may request reasonable modifications in the schedule for the outage. Seller shall use all reasonable efforts to comply with any request to modify the schedule for a Maintenance Outage provided that such change has no substantial impact on Seller. Seller shall notify PacifiCorp of any subsequent changes in generation capacity available to PacifiCorp as a result of such Maintenance Outage or any changes in the Maintenance Outage completion date and time. As soon as practicable, any notifications given orally shall be confirmed in writing. Seller shall take all reasonable measures consistent with Prudent Electrical Practices to minimize the frequency and duration of Maintenance Outages. Notwithstanding anything in this Section 6.5.2 to the contrary, Seller may schedule a Maintenance Outage at any time and without the requirement to notify PacifiCorp in advance during conditions of low solar exposure.

1.32.3 Forced Outages. Seller shall promptly provide to PacifiCorp an oral report, via telephone to a number specified by PacifiCorp (or other method approved by PacifiCorp), of any Forced Outage resulting in more than 10 percent of the Nameplate Capacity Rating of the Facility being unavailable. This report shall include the amount of the generation capacity of the Facility that will not be available because of the Forced Outage and the expected return date of such generation capacity. Seller shall promptly update the report as necessary to advise PacifiCorp of changed circumstances. As soon as practicable, the oral report shall be confirmed in writing by notice to PacifiCorp. Seller shall take all reasonable measures consistent with Prudent Electrical Practices to avoid Forced Outages and to minimize their duration.

1.32.4 Notice of Deratings and Outages. Without limiting the foregoing, Seller will inform PacifiCorp, via telephone to a number specified by PacifiCorp (or other method approved by PacifiCorp), of any major limitations, restrictions, deratings or outages known to Seller affecting the Facility for the following day (except for curtailments pursuant to Section 4.4(b)) and will promptly update Seller's notice to the extent of any material changes in this information, with "major" defined as affecting more than 10 percent of the Nameplate Capacity Rating of the Facility.

1.32.5 Effect of Outages on Estimated Output. Seller represents and warrants that the estimated monthly net output set forth on Exhibit A takes into account the Planned Outages, Maintenance Outages, and Forced Outages that Seller reasonably expects to encounter in the ordinary course of operating the Facility.

1.33 Scheduling.

1.33.1 Cooperation and Standards. With respect to any and all scheduling requirements hereunder, (a) Seller shall cooperate with PacifiCorp with respect to scheduling Net Output, and (b) each Party shall designate authorized representatives to communicate with regard to scheduling and related matters arising hereunder. Each Party shall comply with the applicable variable resource standards and criteria of any applicable Electric System Authority. The Parties agree that any and all scheduling requirements associated with the scheduling and sale of Net Output outside of those specific forecasting activities referenced in Section 6.7 will be performed by PacifiCorp.

1.33.2 Schedule Coordination. If, as a result hereof, PacifiCorp is deemed by an RTO to be financially responsible for Seller's performance under the Generation Interconnection Agreement, due to Seller's lack of standing as a "scheduling coordinator" or other RTO recognized designation, qualification or otherwise, then Seller shall acquire such RTO recognized standing (or shall contract with a third party who has such RTO recognized standing) such that PacifiCorp is no longer responsible for Seller's performance under the Generation Interconnection Agreement or RTO requirement. Notwithstanding the foregoing: (i) the Parties agree that PacifiCorp will assume all "scheduling coordinator" responsibilities and bear all financial costs associated with this obligation on behalf of Seller unless the System becomes part of an RTO; and (ii) if the System becomes part of an RTO at some point in the future the Parties will determine the "scheduling coordinator" roles and responsibilities based on the rules of the RTO at that time.

1.34 Forecasting.

1.34.1 Long-Range Forecasts. For PacifiCorp's planning purposes, Seller shall, by December 1 of each year during the Term (except for the last year of the Term), provide an annual update to the expected long-term monthly/diurnal mean net energy estimates (12 X 24 profile).

1.34.2 Day-Ahead Forecasts and Updates. By such time as mutually agreed to by the Parties on the Business Day immediately preceding the day on which Net Output from the Facility is to be delivered, Seller shall provide PacifiCorp with an hourly forecast of deliveries for each hour of the next day; provided, however, that a forecast provided on a day before any non-Business Day shall include forecasts for each day to and including the next Business Day. The Parties shall cooperate to implement and use automatic forecast updates. Seller shall communicate forecasts under this Section 6.7.2 in an efficient manner, including electronic mail or other such media as determined by PacifiCorp (which, at PacifiCorp's discretion, may be in lieu of or in addition to notice to PacifiCorp). PacifiCorp may, with the advance written consent of Seller and at Seller's expense, add forecasting services for Seller's Facility to PacifiCorp's existing contract with a qualified solar-energy-production forecasting vendor, which contract and vendor may change during the term of this Agreement. The Parties agree that the forecasting obligations of Seller under this Section 6.7 may be met by a solar forecast service provider engaged by PacifiCorp. Upon request by PacifiCorp, Seller shall provide a 24-hour telephone number that PacifiCorp may contact to determine the then-current status of the Facility.

PacifiCorp may at its cost and without the prior consent of Seller add the Facility to PacifiCorp's existing qualified solar-energy-production forecasting vendor contract.

1.34.3 Basis of Forecasts. The forecasts called for by this Agreement shall be non-binding, good faith estimates only, and PacifiCorp expressly releases and holds harmless Seller from any liability for forecasting errors. Seller shall prepare such forecasts and updates by utilizing a solar exposure model or service that is (a) commercially available or proprietary to Seller or an Affiliate of Seller, and (b) comparable in accuracy to models or services commonly used in the solar energy industry, so long as such model or service is available at a commercially reasonable cost and is satisfactory to PacifiCorp in the exercise of its reasonable discretion. On or prior to May 1 during each calendar year in the Term, Seller shall determine in good faith which such model or service to utilize after consultation with PacifiCorp.

1.35 Increase in Nameplate Capacity Rating; New Project Expansion or Development. Without limiting any restrictions herein on Nameplate Capacity Rating, if Seller elects to increase, at its own expense, the ability of the Facility to deliver Net Output in quantities in excess of the Maximum Delivery Rate through any means, including replacement or modification of Facility equipment or related infrastructure, PacifiCorp shall not be required to purchase any Net Output or Green Tags above the Maximum Delivery Rate. If Seller or any Affiliate elects to build an expansion or additional solar project within one mile of the Facility (measured from the nearest generation equipment at both locations), Seller shall have no rights pursuant to this Agreement to require PacifiCorp to purchase (and PacifiCorp shall have no obligation to purchase pursuant to this Agreement) the output of any such expansion or additional facility. Any such expansion or additional facility may not materially and adversely impact the ability of either Party to fulfill its obligations pursuant hereto.

1.36 Electronic Communications.

1.36.1 Telemetry. Seller shall during the Term provide telemetry equipment and facilities capable of transmitting the following information concerning the Facility pursuant to the Generation Interconnection Agreement and to PacifiCorp on a real-time basis, and will operate such equipment when requested by PacifiCorp to indicate:

- (a) instantaneous MW output at the Point of Delivery; and
- (b) Net Output.

Commencing on the earlier of the date of the initial delivery of any Test Energy hereunder and the Commercial Operation Date, Seller shall also transmit or cause to be transmitted to or make accessible to PacifiCorp any other data from the Facility that Seller receives on a real time basis, including meteorological data, solar exposure data and Net Output data. Such real time data shall be provided to or be made accessible to PacifiCorp on the same basis on which Seller receives the data (e.g., if Seller receives the data in four second intervals, PacifiCorp shall also receive the data in four second intervals).

1.36.2 Interconnection Provider Consent. Seller shall execute a consent, in the form required by Interconnection Provider, to provide that PacifiCorp can read the meter and

receive any and all data from the Interconnection Provider relating to transmission of Output or other matters relating to the Facility without the need for further consent from Seller.

1.36.3 Dedicated Communication Circuit. Seller shall install a dedicated direct communication circuit (which may be by common carrier telephone) between PacifiCorp and the control center in the Facility's control room or such other communication equipment as the Parties may agree.

1.37 Reports and Records.

1.37.1 Quarterly Reports. Commencing on the Commercial Operation Date, within 30 days after the end of each calendar quarter during the Term (each, a "Reporting Quarter"), Seller shall provide to PacifiCorp a report in electronic format, which report shall include (a) summaries of the Facility's solar insolation and actual and predicted output data for the Reporting Quarter in intervals not to exceed one hour (or such shorter period as is reasonably possible with commercially available technology), including information from the Facility's computer monitoring system; (b) summaries of any other significant events related to the construction or operation of the Facility for the Reporting Quarter; and (c) any supporting information that PacifiCorp may from time to time reasonably request (including historical solar exposure data for the Facility). PacifiCorp, in its discretion, may waive by providing written notice to Seller, the quarterly reporting requirements required in this Section 6.10.1 if Seller provides sufficient real time data to meet the informational requirements of PacifiCorp.

1.37.2 Electronic Fault Log. Seller shall maintain an electronic fault log of operations of the Facility during each hour of the Term commencing on the Commercial Operation Date. Seller shall provide PacifiCorp with a copy of the electronic fault log within 30 days after the end of the calendar month to which the fault log applies.

1.37.3 Other Information to be Provided to PacifiCorp. Seller shall provide to PacifiCorp the following information concerning the Facility:

- (a) Upon the request of PacifiCorp, the manufacturers' guidelines and recommendations for maintenance of the Facility equipment;
- (b) A report summarizing the results of maintenance performed during each Maintenance Outage, Planned Outage, and any Forced Outage, and upon request of PacifiCorp any of the technical data obtained in connection with such maintenance;
- (c) Before Final Completion, a monthly progress report stating the percentage completion of the Facility and a brief summary of construction activity during the prior month;
- (d) Before Final Completion, a monthly report containing a brief summary of construction activity contemplated for the next calendar month; and
- (e) At any time from the Effective Date, one year's advance notice of the termination or expiration of any material agreement, including Leases, pursuant to which the Facility or any material equipment relating thereto is upon the Premises; provided that the

foregoing does not authorize any early termination of any land lease. In the event Seller has less than one year's advance notice of such termination or expiration, Seller shall provide the notice contemplated by this Section to PacifiCorp within 15 Business Days of Seller obtaining knowledge of the termination or expiration.

1.37.4 Information to Governmental Authorities. Seller shall, promptly upon written request from PacifiCorp, provide PacifiCorp with data collected by Seller related to the construction, operation or maintenance of the Facility reasonably required by PacifiCorp or an Affiliate thereof for reports to, and information requests from, any Governmental Authority or Electric System Authority. Along with this information, Seller shall provide to PacifiCorp copies of all submittals to Governmental Authorities or Electric System Authorities directed by PacifiCorp and related to the operation of the Facility with a certificate that the contents of the submittals are true and accurate to the best of Seller's knowledge. Seller shall use best efforts to provide this information to PacifiCorp with sufficient advance notice to enable PacifiCorp to review such information and meet any submission deadlines imposed by the requesting organization or entity. PacifiCorp shall reimburse Seller for all of Seller's reasonable actual costs and expenses in excess of \$10,000 per year (this amount shall escalate at 2.5 percent per Contract Year), if any, incurred in connection with PacifiCorp's requests for information under this Section 6.10.4.

1.37.5 Data Request. Seller shall, promptly upon written request from PacifiCorp, provide PacifiCorp with data collected by Seller related to the construction, operation or maintenance of the Facility reasonably required for information requests from any Governmental Authorities, state or federal agency intervenor or any other party achieving intervenor status in any PacifiCorp rate proceeding or other proceeding before any Governmental Authority. Seller shall use best efforts to provide this information to PacifiCorp sufficiently in advance to enable PacifiCorp to review it and meet any submission deadlines. PacifiCorp shall reimburse Seller for all of Seller's reasonable actual costs and expenses in excess of \$10,000 per year (this amount shall escalate at 2.5 percent per Contract Year), if any, incurred in connection with PacifiCorp's requests for information under this Section 6.10.5.

1.37.6 Documents to Governmental Authorities. After sending or filing any statement, application, and report or any document with any Governmental Authority or Electric System Authority relating to operation and maintenance of the Facility, Seller shall promptly provide to PacifiCorp a copy of the same.

1.37.7 Environmental Information. Seller shall, promptly upon written request from PacifiCorp, provide PacifiCorp with all data reasonably requested by PacifiCorp relating to environmental information under the Required Facility Documents. Seller shall further provide PacifiCorp with information relating to environmental impact mitigation measures it is taking in connection with the Facility's construction or operation that are required by any Governmental Authority. PacifiCorp shall reimburse Seller for all of Seller's reasonable actual costs and expenses in excess of \$10,000 per year (this amount shall escalate at 2.5 percent per Contract Year), if any, incurred in connection with PacifiCorp's requests for the foregoing information under this Section 6.10.7. As soon as it is known to Seller, Seller shall disclose to PacifiCorp, the extent of any material violation of any environmental laws or regulations arising out of the construction or operation of the Facility, or the presence of Environmental Contamination at the

Facility or on the Premises, alleged to exist by any Governmental Authority having jurisdiction over the Premises, or the present existence of, or the occurrence during Seller's occupancy of the Premises of, any enforcement, legal, or regulatory action or proceeding relating to such alleged violation or alleged presence of Environmental Contamination presently occurring or having occurred during the period of time that Seller has occupied the Premises.

1.37.8 Operational Reports. Seller shall provide PacifiCorp quarterly (on a calendar year basis) operational reports in a form and substance reasonably acceptable to PacifiCorp, and Seller shall, promptly upon written request from PacifiCorp, provide PacifiCorp with all operational data requested by PacifiCorp with respect to the performance of the Facility and delivery of Net Output or Capacity Rights therefrom.

1.37.9 Notice of Material Adverse Events. Seller shall promptly notify PacifiCorp of receipt of written notice or actual knowledge by Seller or its Affiliates of the occurrence of any event of default under any material agreement to which Seller is a party and of any other development, financial or otherwise, which would have a material adverse effect on Seller, the Facility or Seller's ability to develop, construct, operate, maintain or own the Facility as provided herein.

1.37.10 Notice of Litigation. Following its receipt of written notice or actual knowledge of the commencement of any action, suit, or proceeding before any court or Governmental Authority against Seller or its members with respect to this Agreement or the transactions contemplated hereunder, Seller shall promptly give notice to PacifiCorp of the same. Following its receipt of written notice or actual knowledge of the commencement of any action, suit or proceeding before any court or Governmental Authority against Seller, its members or any Affiliate, the effect of which would materially and adversely affect Seller's performance of its obligations hereunder, Seller shall promptly give notice to PacifiCorp of the same.

1.37.11 Additional Information. Seller shall provide to PacifiCorp such other information respecting the condition or operations of Seller, as such pertains to Seller's performance of its obligations hereunder, or the Facility as PacifiCorp may, from time to time, reasonably request.

1.37.12 Confidential Treatment. The monthly reports and other information provided to PacifiCorp under this Section 6.10 shall be treated as Confidential Business Information if such treatment is requested in writing by Seller at the time the information is provided to PacifiCorp, subject to PacifiCorp's rights to disclose such information pursuant to Sections 6.10.4, 6.10.5, 6.10.7, 9.5, 9.6, 23.2 and 23.3, and pursuant to any applicable Requirements of Law. Seller shall have the right to seek confidential treatment of any such information from the Governmental Authority entitled to receive such information.

1.38 Financial and Accounting Information. If PacifiCorp or one of its Affiliates determines that, under (i) the Accounting Standards Codification (ASC) 810, Consolidation of Variable Interest Entities, and (ii) Requirements of Law that it may hold a variable interest in Seller, but it lacks the information necessary to make a definitive conclusion, Seller hereby agrees to provide, upon PacifiCorp's written request, sufficient financial and ownership information so that PacifiCorp or its Affiliate may confirm whether a variable interest does exist

under ASC 810 and Requirements of Law. If PacifiCorp or its Affiliate determines that, under ASC 810, it holds a variable interest in Seller, Seller hereby agrees to provide, upon PacifiCorp's written request, sufficient financial and other information to PacifiCorp or its Affiliate so that PacifiCorp may properly consolidate the entity in which it holds the variable interest or present the disclosures required by ASC 810 and Requirements of Law. PacifiCorp shall reimburse Seller for Seller's reasonable costs and expenses, if any, incurred in connection with PacifiCorp's requests for information under this Section 6.11. The information provided to PacifiCorp under this Section 6.11 shall be treated as Confidential Business Information if at the time the Seller provides such information to PacifiCorp the Seller provides written notice that the information is Confidential Business Information. Seller shall have the right to seek confidential treatment of any such information from any Governmental Authority entitled to receive such information. Information provided pursuant to this Section is subject to PacifiCorp's rights to disclose such information pursuant to Sections 6.10.4, 6.10.5, 6.10.7, 9.5, 9.6, 23.2 and 23.3, and pursuant to any applicable Requirements of Law.

1.39 Output Guarantee.

1.39.1 Output Guarantee. Seller is obligated to deliver a quantity of Net Output during each Rolling Period which is equal to the Output Guarantee. For purposes of this Agreement, "Output Guarantee" for any Rolling Period means the sum of (i) [REDACTED] % of the Expected Output of the Facility for such Rolling Period, less (ii) any quantities of Output that were not delivered to the Point of Delivery (or accepted by PacifiCorp) in such Rolling Period during periods constituting Seller Uncontrollable Minutes (such quantity calculated on the basis of the Net Output capable of being delivered in an hour at an average rate equivalent to the actual Nameplate Capacity Rating). For purposes of this Agreement, "Rolling Period" means any two consecutive Contract Years occurring during the Term.

1.39.2 Liquidated Damages for Output Shortfall.

(a) If the quantity of Net Output delivered by the Facility during any Rolling Period is equal to or greater than the Output Guarantee for such Rolling Period, Seller's delivery obligation for such Rolling Period shall be deemed satisfied for such Rolling Period.

(b) If the quantity of Net Output delivered by the Facility during any Rolling Period is less than the Output Guarantee for such Rolling Period, the Seller shall determine the resulting shortfall, if any, for the first Contract Year occurring during such Rolling Period (the "Output Shortfall"). The Output Shortfall shall be expressed in MWh and calculated in accordance with the following formula:

Output Shortfall = [REDACTED] of the Expected Output for the Contract Year).

less

Any quantities of Output that were not delivered to the Point of Delivery (or accepted by PacifiCorp) in such Contract Year during periods constituting Seller Uncontrollable Minutes (such quantity calculated on the basis of the Net Output capable of being delivered

in an hour at an average rate equivalent to the actual Nameplate Capacity Rating),

less

The Net Output for the Contract Year

(c) If the product of the Output Shortfall calculation set forth in Section 6.12.2(b) is a positive number, Seller shall pay PacifiCorp liquidated damages equal to the product of (a) the Output Shortfall for that Contract Year, multiplied by (b) PacifiCorp's Cost to Cover for that Contract Year. If the product of the Output Shortfall calculation set forth in Section 6.12.2(b) is a negative number, Seller shall not be obligated to pay PacifiCorp liquidated damages for such Contract Year.

(d) Each Party agrees and acknowledges that (i) the damages that PacifiCorp would incur due to the Facility's failure to achieve the Output Guarantee would be difficult or impossible to predict with certainty, (ii) the liquidated damages contemplated by this provision are a fair and reasonable calculation of such damages and (iii) such liquidated damages shall be PacifiCorp's sole and exclusive remedy for the Facility's failure to achieve the Output Guarantee.

1.39.3 Annual Invoicing. On the thirtieth day following the end of each Rolling Period, Seller shall deliver to PacifiCorp a report (and supporting data) detailing whether Seller achieved the Output Guarantee for the most recently completed Rolling Period. In the case of the Seller failing to achieve the Output Guarantee in the prior Rolling Period, Seller shall also provide a report (and supporting data) to PacifiCorp detailing the Output Shortfall for the first Contract Year occurring during such Rolling Period. Seller shall provide documentation to support all data and calculations used in each report to calculate the percent of Expected Output used in such report. Thirty days after PacifiCorp has received the report and all support data, if applicable, PacifiCorp shall deliver to Seller an invoice showing PacifiCorp's computation of liquidated damages calculated pursuant to Section 6.12.2. In preparing such invoices, PacifiCorp shall utilize the meter data provided to PacifiCorp for the Contract Year in question, but may also rely on historical averages and such other information as may be available to PacifiCorp at the time of invoice preparation, if the meter data for such Contract Year is then incomplete or otherwise not available. To the extent required, PacifiCorp shall true up any such invoice as promptly as practicable following its receipt of actual results for the relevant Contract Year. Seller shall pay to PacifiCorp, by wire transfer of immediately available funds to an account specified in writing by PacifiCorp or by any other means agreed to by the Parties in writing from time to time, the amount set forth as due in such invoice, and shall within 30 days after receiving the invoice raise any objections regarding any disputed portion of the invoice. All disputes regarding such invoices shall be subject to Section 10.4. Objections not made by Seller within the 30-day period shall be deemed waived.

1.40 Access Rights. Upon reasonable prior notice and subject to the prudent safety requirements of Seller, and Requirements of Law relating to workplace health and safety, Seller shall provide PacifiCorp and its authorized agents, employees and inspectors ("PacifiCorp Representatives") with reasonable access to the Facility: (a) for the purpose of reading or testing

metering equipment, (b) as necessary to witness any acceptance tests, (c) to provide tours of the Facility to customers and other guests of PacifiCorp (not more than 12 times per year), (d) for purposes of implementing Sections 2.7 or 10.5, and (e) for other reasonable purposes at the reasonable request of PacifiCorp. PacifiCorp shall release Seller against and from any and all Liabilities resulting from actions or omissions by any of the PacifiCorp Representatives in connection with their access to the Facility, except to the extent that such damages are caused by the intentional or grossly negligent act or omission of Seller.

1.41 Facility Images. PacifiCorp shall be free to use any and all images from or of the Facility for promotional purposes, subject to Seller's consent (not to be unreasonably withheld or delayed, and which consent may consider Requirements of Law relating to Premises security, obligations to outside vendors (including any confidentiality obligations), and the corporate policies of Seller's Affiliates). Upon PacifiCorp's request and at PacifiCorp's expense, Seller shall install imaging equipment at the Facility as PacifiCorp may request, including video and or web-based imaging equipment subject to the prudent safety requirements of Seller, and Requirements of Law relating to workplace health and safety. PacifiCorp shall retain full discretion on how such images are presented including associating images of the Facility with a PacifiCorp-designated corporate logo.

SECTION 7 QUALIFYING FACILITY STATUS

1.42 Seller's QF Status. Seller covenants that, during the Term and before delivering Net Output and associated Green Tags to PacifiCorp hereunder, Seller shall cause the Facility to be a QF.

1.43 QF Facility. Seller shall provide PacifiCorp with copies of the appropriate certification (which may include a FERC self-certification) within ten (10) days of filing or receiving the certification. During the Term, Seller shall, to the extent required to prevent Seller from being regulated as a "Public Utility" pursuant to PUHCA or otherwise, maintain its QF status, and shall not seek to change the Contract Price as a result of its status as a QF. At any time during the Term of this Agreement, PacifiCorp may require Seller, at Seller's sole cost, to provide PacifiCorp with evidence satisfactory to PacifiCorp in its reasonable discretion that the Facility continues to qualify as a QF under all applicable requirements and, if PacifiCorp is not satisfied that the Facility qualifies for such status, a written legal opinion from an attorney who is (a) in good standing before a state bar in the United States, and (b) has no economic relationship, association or nexus with the Seller or the Facility, stating that the Facility is a QF and providing sufficient proof (including copies of all documents and data as PacifiCorp may request) demonstrating that Seller has maintained and will continue to maintain the Facility as a QF.

SECTION 8 SECURITY AND CREDIT SUPPORT

1.44 Project Development Security. Project Development Security is not required if Seller meets the Credit Requirements. Seller shall provide within five Business Days from receipt of a written request from PacifiCorp all reasonable financial records necessary for PacifiCorp to confirm Seller satisfies the Credit Requirements.

1.44.1 Form and Amount of Project Development Security. If at any time Seller does not satisfy the Credit Requirements, then on or before the date specified in Section 2.3(a), Seller shall post and maintain in favor of PacifiCorp (a) a guaranty from a party that satisfies the Credit Requirements, in substantially the form attached hereto as Exhibit 8.2.1, or (b) a Letter of Credit in favor of PacifiCorp, in a form acceptable to PacifiCorp in its reasonable discretion, equal in each case to [REDACTED] per kW of Expected Nameplate Capacity Rating (the "Project Development Security"). Seller and any party providing a guaranty for Seller shall provide within five Business Days from receipt of a written request from PacifiCorp all reasonable financial records necessary for PacifiCorp to confirm Seller and/or the guarantor satisfies the Credit Requirements.

1.44.2 Use of Project Development Security to Pay Delay Damages. If the Commercial Operation Date occurs after the Scheduled Commercial Operation Date and Seller has failed to pay any Delay Damages when due under Section 2.5, PacifiCorp shall be entitled to and shall draw upon the Project Development Security an amount equal to the Delay Damages until such time as the Project Development Security is exhausted. PacifiCorp shall also be entitled to draw upon the Project Development Security for other damages if this Agreement is terminated under Section 11 because of Seller's default.

1.44.3 Termination of Project Development Security. Seller shall no longer be required to maintain the Project Development Security (or the remaining balance thereof) after the Commercial Operation Date, if at such time no damages are owed to PacifiCorp under this Agreement. However, as of the Commercial Operation Date, Seller may elect to apply the Project Development Security toward the Default Security required by Section 8.2, including by the automatic continuation (as opposed to the replacement) thereof.

1.45 Default Security.

1.45.1 Duty to Post Default Security. Beginning on the date specified in Section 2.3(b), at any time during the Term when Seller does not satisfy the Credit Requirements, Seller shall post and maintain in favor of PacifiCorp (a) a guaranty from an entity that satisfies the Credit Requirements, in substantially the form attached hereto as Exhibit 8.2.1, or (b) a Letter of Credit (the "Default Security"), as provided in this Section 8.2. In the event Seller posts Default Security and thereafter satisfies the Credit Requirements, as demonstrated to the reasonable satisfaction of PacifiCorp, then Seller shall be entitled to a release by PacifiCorp of the Default Security for so long as Seller continues to satisfy the Credit Requirements. Seller and any party providing a guaranty for Seller shall provide within five Business Days from receipt of a written request from PacifiCorp all reasonable financial records necessary for PacifiCorp to confirm Seller and/or the guarantor satisfies the Credit Requirements.

1.45.2 Amount of Default Security. The amount of the Default Security required by Section 8.2.1 will be [REDACTED]

1.46 Intentionally Deleted.

1.47 Intentionally Deleted.

1.48 Step In Rights.

1.48.1 Failure to Achieve Commercial Operation. If Seller fails to achieve Commercial Operation of the Facility by the Guaranteed Commercial Operation Date, PacifiCorp shall have the right to enter the Facility and do all such things as PacifiCorp may consider necessary or desirable to complete the Facility and cause Commercial Operation to occur. PacifiCorp shall, following the Commercial Operation Date (a) return the Facility to Seller upon execution of an indemnity and release by Seller of all claims arising out of the period of PacifiCorp's entry on the Facility in a form reasonably acceptable to the Parties or (b) failing the execution of such release or indemnity, (i) operate the Facility for the Term pursuant to Section 8.4.2 or (ii) terminate this Agreement without payment of any damages. Seller shall indemnify and hold PacifiCorp harmless from and against all losses, costs, charges and expenses incurred by PacifiCorp in connection with exercise of its rights under this Section 8.4.1, whether to third parties or otherwise, other than due to the gross negligence or willful misconduct of PacifiCorp.

1.48.2 License to Operate Facility. Seller hereby irrevocably grants to PacifiCorp the right, license, and authority to enter the Premises, operate the Facility, and to perform Seller's obligations hereunder for the Term during the continuance of an Event of Default by Seller (such rights along with those rights set forth in Section 8.4.1, "Step-In Rights"). PacifiCorp may, but shall not be obligated to, exercise its rights as licensee under this Section in lieu of termination. During any period in which PacifiCorp is operating the Facility pursuant to the license granted in this Section, Seller shall, upon request from PacifiCorp, reimburse PacifiCorp for all reasonable costs and expenses incurred by PacifiCorp to operate and maintain the Facility.

1.48.3 Not Used.

1.48.4 Records and Access. Seller shall collect and have available at a convenient, central location all documents, contracts, books, manuals, reports, and records required to construct, operate, and maintain the Facility in accordance with Prudent Electrical Practices. Upon PacifiCorp's notice of intent to exercise Step-In Rights, PacifiCorp, its employees, contractors, or designated third parties shall have the right to enter the Premises and the Facility for the purpose of constructing or operating the Facility. Upon the exercise by PacifiCorp of the Step-In Rights, Seller shall cause the Facility operator (and any person within the control of Seller) to give PacifiCorp access to and control of the operation and maintenance of the Facility to the extent reasonably necessary to enable PacifiCorp to exercise the Step-In Rights in respect of the part of the Facility so to be operated by PacifiCorp, and shall provide reasonable assistance and cooperation to PacifiCorp to effect safely the transfer of operational responsibility as may be requested by PacifiCorp. Seller shall execute such documents and take such other action as may be necessary for PacifiCorp to effectuate its rights under this Section 8.4.6.

1.48.5 Return. PacifiCorp may, at any time, terminate its exercise of the Step-In Rights whether or not the applicable event has been cured. If at any time after exercising its Step-In Rights, PacifiCorp elects to return possession of the Facility to Seller, PacifiCorp shall provide Seller with at least ten (10) days advance notice of the date PacifiCorp intends to return

such possession, and upon receipt of such notice Seller shall take all measures necessary to resume possession of the Facility on such date.

1.48.6 No Assumption. PacifiCorp's exercise of its Step-In Rights shall not be deemed an assumption by PacifiCorp of any liability of Seller due and owing prior to the exercise of such rights. PacifiCorp shall not assume any liability of Seller for the period during which PacifiCorp exercises its Step-In Rights. During any period that PacifiCorp is exercising its Step-In Rights, Seller shall retain legal title to and ownership of the Facility and all of its other property and its revenues. When exercising its Step-In Rights, PacifiCorp shall assume possession, operation, and control of the Facility solely as an agent for Seller. In no event shall PacifiCorp's election to exercise the Step-In Rights be deemed to constitute a transfer of ownership of or title to the Facility or any assets of Seller.

1.48.7 Costs and Expenses. Seller shall indemnify and hold harmless PacifiCorp from and against all reasonable losses, costs, charges and expenses incurred by PacifiCorp in connection with exercise of its Step-In Rights, other than losses, costs, charges and expenses attributable to the gross negligence or willful misconduct of PacifiCorp. In connection with its exercise of Step-In Rights, PacifiCorp shall have the right to recoup and set off all such losses, costs, charges and expenses against amounts otherwise owed by PacifiCorp hereunder. PacifiCorp's exercise of such recoupment and set off rights shall not limit the other remedies available to PacifiCorp hereunder or otherwise.

1.49 Annual Financial Statements. If requested by PacifiCorp from time to time, Seller shall within thirty (30) days provide PacifiCorp with copies of its most recent annual financial statements, which shall include the percentage of Facility Equity. For purposes of this Section, "Facility Equity" means the aggregate amount, as of the Commercial Operation Date, of equity investment in the Facility by any owner, investor, or other party, including, but not limited to, tax equity investors. The phrase "percentage of Facility Equity" means the ratio, expressed as a percentage, of the Facility Equity to the sum of (a) all indebtedness outstanding to third parties and (b) the amount of Facility Equity. No indebtedness relating to the Default Security described in Section 8 shall be included in the indebtedness described in clause (a) above.

1.50 Security is Not a Limit on Seller's Liability. The security contemplated by this Section 8 (a) constitutes security for, but is not a limitation of, Seller's obligations hereunder and (b) shall not be PacifiCorp's exclusive remedy for Seller's failure to perform in accordance with this Agreement. Seller shall maintain security as required by Sections 8.1 and 8.2. To the extent that PacifiCorp draws on any security, Seller shall, on or before the first day of the Contract Year following such draw, replenish or reinstate the security to the full amount then required under this Section 8. If at any time the Seller or Seller's credit support provider(s) fails to meet the Credit Requirements, then Seller shall provide replacement security meeting the requirements set forth in Section 8 within 10 Business Days after the earlier of (x) Seller's receipt of notice from any source that Seller or the credit support provider(s), as applicable, no longer meets the Credit Requirements or (y) Seller's receipt of written notice from PacifiCorp requesting the posting of alternate security.

1.51 Senior Lender Assurances. Upon written request of Seller for the benefit of any Senior Lenders ("Lender Request"), PacifiCorp agrees to provide the following written

assurances to such Senior Lenders, in each case to the extent requested by such Senior Lenders:

1.51.1 That neither PacifiCorp nor, to PacifiCorp's actual knowledge, Seller, is in default of any of its obligations hereunder;

1.51.2 That to the best of PacifiCorp's actual knowledge, (i) no Force Majeure Event exists under, and as defined in, this Agreement and (ii) no event or condition exists which would either immediately or with the passage of any applicable grace period or giving of notice, or both, enable either PacifiCorp or Seller to terminate or suspend its obligations under this Agreement;

1.51.3 That PacifiCorp agrees to make directly to the Person specified in such Lender Request all payments to be made by PacifiCorp to Seller hereunder from and after PacifiCorp's receipt of such Lender Request;

1.51.4 That PacifiCorp shall give notice of an Event of Default by Seller, to the person(s) to be specified by such Senior Lenders in such Lender Request, before exercising its right to terminate this Agreement as a result of such Event of Default;

1.51.5 That such Senior Lenders will have the right to cure an Event of Default on behalf of Seller, only if such Senior Lenders send a written notice to PacifiCorp before the end of any cure period indicating Senior Lender's intention to cure. The Senior Lenders must remedy or cure the Event of Default within the cure period under this Agreement;

1.51.6 That the Senior Lenders will have the right to consent before any termination of this Agreement which does not arise out of an Event of Default;

1.51.7 That the Senior Lenders will receive prior notice of material amendments to this Agreement;

1.51.8 That if possession of the Project is necessary to cure and breach or default hereunder, and the Senior Lenders or their designees or assignees have declared Seller in default and commence foreclosure proceedings, the Senior Lenders or their designees or assignees will be allowed a reasonable period to complete such proceedings; and

1.51.9 That, to the extent permitted by applicable law, PacifiCorp consents to the transfer of Seller's interest under this Agreement to the Senior Lenders or their designees or assignees or any of them or a purchaser or grantee pursuant to the terms of the applicable financing documents upon enforcement of such security at a foreclosure sale by judicial or nonjudicial foreclosure and sale or by a conveyance by Seller in lieu of foreclosure and, to the extent permitted by applicable law, agrees that upon such foreclosure, sale or conveyance, PacifiCorp shall recognize the Senior Lenders or their designees or assignees or any of them or other purchaser or grantee as the applicable party under this Agreement (provided that such Senior Lenders or their designees or assignees or purchaser or grantee assume the obligations of Seller under the Agreement, including satisfaction and compliance with all requirements of Article 8).

SECTION 9

METERING

1.52 Installation of Metering Equipment. Metering equipment shall be designed, furnished, installed, owned, inspected, tested, maintained and replaced as provided in the Generation Interconnection Agreement; provided, however, that PacifiCorp acting in its merchant function capacity shall be under no obligation, pursuant hereto, to bear any expense relating to such metering equipment.

1.53 Metering. Metering shall be performed at the location and in the manner specified in Exhibit 9.2, the Generation Interconnection Agreement and as necessary to perform Seller's obligations hereunder. All quantities of Net Output purchased hereunder shall reflect the net amount of energy flowing into the System at the Point of Delivery.

1.54 Inspection, Testing, Repair and Replacement of Meters. PacifiCorp shall have the right to periodically inspect, test, repair and replace the metering equipment that are provided for in the Generation Interconnection Agreement, without PacifiCorp assuming any obligations thereunder. If any of the inspections or tests disclose an error exceeding 0.5 percent, either fast or slow, proper correction, based upon the inaccuracy found, shall be made of previous readings for the actual period during which the metering equipment rendered inaccurate measurements if that period can be ascertained. If the actual period cannot be ascertained, the proper correction shall be made to the measurements taken during the time the metering equipment was in service since last tested, but not exceeding three months, in the amount the metering equipment shall have been shown to be in error by such test. Any correction in billings or payments resulting from a correction in the meter records shall be made in the next monthly billing or payment rendered. Such correction, when made, shall constitute full adjustment of any claim between Seller and PacifiCorp arising out of such inaccuracy of metering equipment. Nothing in this Agreement shall give rise to PacifiCorp, acting in its merchant function capacity hereunder, having any obligations to Seller, or any other person or entity, pursuant to or under the Generation Interconnection Agreement.

1.55 Metering Costs. To the extent not otherwise provided in the Generation Interconnection Agreement, Seller shall bear all costs (including PacifiCorp's costs) relating to all metering equipment installed to accommodate Seller's Facility.

1.56 Meter Data. Within 10 days of the Effective Date, Seller may request the Interconnection Provider or Network Service Provider in writing in a form similar to that found in Exhibit 9.5 to provide any and all meter or other data associated with the Facility or Net Output directly to PacifiCorp. Should Seller refuse to provide a release similar to that found in Exhibit 9.5, Seller shall establish a mechanism at its expense that allows PacifiCorp, in its merchant function, to obtain all necessary meter and other data to fully perform and verify Seller's performance under this Agreement. Notwithstanding any other provision hereof, PacifiCorp shall have the right to provide such data to any Electric System Authority.

1.57 WREGIS Metering. Seller shall cause the Facility to implement all necessary generation information communications in WREGIS, and report generation information to WREGIS pursuant to a WREGIS-approved meter that is dedicated to the Facility and only the Facility.

SECTION 10
BILLINGS, COMPUTATIONS AND PAYMENTS

1.58 Monthly Invoices. On or before the 10th day following the end of each calendar month, Seller shall deliver to PacifiCorp a proper invoice showing Seller's computation of Net Output delivered to the Point of Delivery during such month. When calculating the invoice, Seller shall provide computations showing the portion of Net Output that was delivered during On-Peak Hours and the portion of Net Output that was delivered during Off-Peak Hours. If such invoice is delivered by Seller to PacifiCorp, then PacifiCorp shall send to Seller, on or before the later of the 20th day following receipt of such invoice or the 30th day following the end of each month, payment for Seller's deliveries of Net Output and Green Tags to PacifiCorp.

1.59 Offsets. Either Party may offset any payment due hereunder against amounts owed by the other Party pursuant hereto. Either Party's exercise of recoupment and set off rights shall not limit the other remedies available to such Party hereunder.

1.60 Interest on Late Payments. Any amounts that are not paid when due hereunder shall bear interest at the Contract Interest Rate from the date due until paid.

1.61 Disputed Amounts. If either Party, in good faith, disputes any amount due pursuant to an invoice rendered hereunder, such Party shall notify the other Party of the specific basis for the dispute and, if the invoice shows an amount due, shall pay that portion of the statement that is undisputed, on or before the due date. Except with respect to invoices provided under Section 6.12.3, any such notice shall be provided within two years of the date of the invoice in which the error first occurred. If any amount disputed by such Party is determined to be due the other Party, or if the Parties resolve the payment dispute, the amount due shall be paid within five days after such determination or resolution, along with interest at the Contract Interest Rate from the date due until the date paid.

1.62 Audit Rights. Each Party, through its authorized representatives, shall have the right, at its sole expense upon reasonable notice and during normal business hours, to examine and copy the records of the other Party to the extent reasonably necessary to verify the accuracy of any statement, charge or computation made hereunder or to verify the other Party's performance of its obligations hereunder. Upon request, each Party shall provide to the other Party statements evidencing the quantities of Net Output delivered at the Point of Delivery. If any statement is found to be inaccurate, a corrected statement shall be issued and any amount due thereunder will be promptly paid and shall bear interest at the Contract Interest Rate from the date of the overpayment or underpayment to the date of receipt of the reconciling payment. Notwithstanding the foregoing, no adjustment shall be made with respect to any statement or payment hereunder unless a Party questions the accuracy of such payment or statement within two years after the date of such statement or payment.

SECTION 11
DEFAULTS AND REMEDIES

1.63 Defaults. The following events are defaults (each a "default" before the passing of applicable notice and cure periods, and an "Event of Default" thereafter) hereunder:

1.63.1 Defaults by Either Party.

(a) A Party fails to make a payment when due hereunder if the failure is not cured within 10 days after the non-defaulting Party gives the defaulting Party a notice of the default, except with respect to any amount being disputed by a Party pursuant to Section 10.4.

(b) A Party (i) makes a general assignment for the benefit of its creditors; (ii) files a petition or otherwise commences, authorizes or acquiesces in the commencement of a proceeding or cause of action under any bankruptcy or similar law for the protection of creditors, or has such a petition filed against it and such petition is not withdrawn or dismissed within 60 days after such filing; (iii) becomes insolvent; or (iv) is unable to pay its debts when due.

(c) Subject to the limitations set forth in Section 3.4, a Party breaches a representation or warranty made by it herein if the breach is not cured within 30 days after the non-defaulting Party gives the defaulting Party a notice of the default; provided, however, that, upon written notice from the defaulting Party, this 30 day period shall be extended by an additional 60 days if (i) the failure cannot reasonably be cured within the 30 day period despite diligent efforts, (ii) the default is capable of being cured within the additional 60 day period, and (iii) the defaulting Party commences the cure within the original 30 day period and is at all times thereafter diligently and continuously proceeding to cure the failure.

(d) A Party otherwise fails to perform any material obligation hereunder for which an exclusive remedy is not provided hereunder and which is not addressed in any other Event of Default described in Section 11.1, if the failure is not cured within 30 days after the non-defaulting Party gives the defaulting Party notice of the default; provided, however, that, upon written notice from the defaulting Party, the 30 day period shall be extended by an additional 60 days if (i) the failure cannot reasonably be cured within the 30 day period despite diligent efforts, (ii) the default is capable of being cured within the additional 60 day period, and (iii) the defaulting Party commences the cure within the original 30 day period and is at all times thereafter diligently and continuously proceeding to cure the failure.

1.63.2 Defaults by Seller.

(a) Seller fails to post, increase, or maintain the Project Development Security or Default Security as required under, and by the applicable dates set forth in, Section 2 and Section 8 and such failure continues for fifteen (15) days after Seller's receipt of written notice thereof from PacifiCorp.

(b) Seller fails to cause the Facility to achieve Commercial Operation on or before the Guaranteed Commercial Operation Date.

(c) Seller sells Output, Green Tags or Capacity Rights from the Facility to a party other than PacifiCorp in breach of Section 4.2, if Seller does not permanently cease such sale and compensate PacifiCorp for the damages arising from the breach within 10 days after PacifiCorp gives Seller a notice of default.

(d) PacifiCorp receives notice of foreclosure of the Facility or any part thereof by a Lender, mechanic or materialman, or any other holder, of an unpaid lien or other charge or encumbrance, if the same has not been stayed, paid, or bonded around within 10 days of the date of the notice received by PacifiCorp.

(e) After the Commercial Operation Date, Seller fails to maintain any Required Facility Documents or Permits necessary to own or operate the Facility and such failure continues for thirty (30) days after Seller's receipt of written notice thereof from PacifiCorp; provided, however, that upon written notice from Seller, the thirty (30) day period shall be extended by an additional sixty (60) days if (i) the failure cannot reasonably be cured within the thirty (30) day period despite diligent efforts, (ii) the default is capable of being cured within the additional sixty (60) day period, and (iii) Seller commences the cure within the original thirty (30) day period and is at all times thereafter diligently and continuously proceeding to cure the failure.

(f) Seller's Abandonment of construction or operation of the Facility and such failure continues for thirty (30) days after Seller's receipt of written notice thereof from PacifiCorp, except to the extent caused by an event of Force Majeure or a default by PacifiCorp.

(g) Seller fails to maintain insurance as required by the Agreement and such failure continues for fifteen (15) days after Seller's receipt of written notice thereof from PacifiCorp.

(h) Seller fails to meet the Output Guarantee for three consecutive years.

1.64 Remedies for Failure to Deliver/Receive.

1.64.1 Remedy for Seller's Failure to Deliver. Upon the occurrence and during the continuation of a default of Seller under Section 11.1.2(c), Seller shall pay PacifiCorp within five Business Days after invoice receipt, an amount equal to (a) PacifiCorp's Cost to Cover multiplied by the Net Output delivered to a party other than PacifiCorp, (b) additional transmission charges, if any, reasonably incurred by PacifiCorp in moving replacement energy to the Point of Delivery or if not there, to such points in PacifiCorp's control area as are determined by PacifiCorp, and (c) any additional cost or expense incurred as a result of Seller's default under Section 11.1.2(c), as determined by PacifiCorp in a commercially reasonable manner (but not including any penalties, ratcheted demand or similar charges). The invoice for such amount shall include a written statement explaining in reasonable detail the calculation of such amount.

1.64.2 Remedy for PacifiCorp's Failure to Purchase. If PacifiCorp fails to receive or purchase all or part of the Net Output or Green Tags required to be purchased pursuant hereto and such failure is not excused under the terms hereof or by Seller's failure to perform, then Seller shall perform under Section 11.6 and PacifiCorp shall pay Seller, on the earlier of the date payment would otherwise be due in respect of the month in which the failure occurred or within five Business Days after invoice receipt, an amount equal to Seller's Cost to Cover multiplied by the amount of Net Output and Green Tags (a) not so purchased or (b) not so

generated because PacifiCorp curtailed the Facility and such curtailment is not permitted pursuant to Section 4.4 (such energy not so generated to be calculated in the manner described in Section 4.4), less amounts received by Seller pursuant to Section 11.6.

1.64.3 Remedy for Seller's Failure to Sell/Deliver Capacity Rights. Seller shall be liable for PacifiCorp's actual damages in the event Seller fails to sell or deliver all or any portion of the Capacity Rights to PacifiCorp.

1.65 Termination and Remedies. From and during the continuance of an Event of Default, the non-defaulting Party shall be entitled to all remedies available at law or in equity, and may terminate this Agreement by notice to the other Party designating the date of termination and delivered to the defaulting Party no less than one (1) Business Day before such termination date. The notice required by this Section 11.3 may be provided in the notice of default (and does not have to be a separate notice) so long as it complies with all other terms of this Section 11.3. As a precondition to Seller's exercise of this termination right, Seller must also provide copies of such notice to the notice addresses of then-current President and General Counsel of PacifiCorp set forth in Section 22. Such copies shall be sent by registered overnight delivery service or by certified or registered mail, return receipt requested. In addition, any termination notice sent by Seller shall state prominently therein in type font no smaller than 14-point all-capital letters that "THIS IS A TERMINATION NOTICE UNDER A SOLAR PPA. YOU MUST CURE A DEFAULT, OR THE PPA WILL BE TERMINATED," and shall state therein any amount purported to be owed and wiring instructions. Seller will not have the right to terminate this Agreement if the default that gave rise to the termination right is cured within 15 Business Days of receipt of such notice. Further, from and after the date upon which Seller fails to remedy a default within the time periods provided in Section 11.1, and until PacifiCorp has recovered all damages incurred on account of such default by Seller, without exercising its termination right, PacifiCorp may offset its damages against any payment due Seller. Except in circumstances in which a remedy provided for in this Agreement is described as a Party's sole or exclusive remedy, upon termination, the non-defaulting Party may pursue any and all legal or equitable remedies provided by law, equity or this Agreement (including Section 24.6). The rights contemplated by this Section 11 are cumulative such that the exercise of one or more rights shall not constitute a waiver of any other rights. In the event of a termination hereof:

(a) Each Party shall pay to the other all amounts due the other hereunder for all periods prior to termination, subject to offset by the non-defaulting Party against damages incurred by such Party.

(b) The amounts due pursuant to Section 11.3(a) shall be calculated and paid within 30 days after the billing date for such charges and shall bear interest thereon at the Contract Interest Rate from the date of termination until the date paid. The foregoing does not extend the due date of, or provide an interest holiday for any payments otherwise due hereunder.

(c) Before and after the effective date of termination, the non-defaulting Party may pursue, to the extent permitted by this Agreement, any and all legal or equitable remedies provided by law, equity or this Agreement (including Section 24.5).

(d) Without limiting the generality of the foregoing, the provisions of Sections 4.5, 5.4, 5.5, 6.10.4, 6.10.5, 6.10.7, 10.3, 10.4, 10.5, 11.3, 11.4, 11.5, 11.6, 11.7, 11.8, and Section 12, Section 13, Section 23, and Section 24 shall survive the termination hereof.

1.66 Termination of Duty to Buy; Memorandum of Agreement. If this Agreement is terminated following the Commercial Operation Date because of a default by Seller, neither Seller (or any Affiliate), nor any successor to Seller with respect to the ownership of the Facility or Premises, may thereafter require or seek to require PacifiCorp to enter into a power purchase agreement or otherwise purchase energy or capacity from the Facility or any facility constructed on the Premises under PURPA, or any other Requirements of Law, for any periods that would have been within the Term had this Agreement remained in effect. Seller, on behalf of itself and on behalf of any other entity on whose behalf it may act, hereby waives its rights to require PacifiCorp to do so; provided, however, that, notwithstanding the foregoing, such prohibition on seeking or requiring PacifiCorp to enter into a power purchase agreement or otherwise purchase energy or capacity as described above shall not apply in the event that any proposed replacement agreement incorporates the Contract Price attached hereto as Exhibit 5.1. If this Agreement is terminated prior to the Commercial Operation Date because of a default by Seller, for a period of two (2) years following the date of such termination, neither Seller (or any Affiliate), nor any successor to Seller with respect to the ownership of the Facility or Premises, may thereafter require or seek to require PacifiCorp to enter into a power purchase agreement or otherwise purchase energy or capacity from the Facility or any facility constructed on the Premises under PURPA or any other Requirements of Law using any Contract Price other than that provided in Exhibit 5.1 attached hereto. Following this two (2) year period, Seller, Affiliate or successor to Seller may seek a new power purchase agreement with PacifiCorp for the Facility or for a facility to be constructed on the Premises, though PacifiCorp shall not be obligated to provide in such power purchase agreement avoided cost prices that are higher than the avoided cost prices contained in this Agreement for any sales of energy or capacity to PacifiCorp under that power purchase agreement prior to the expiration of five (5) years from the date this Agreement is terminated as a result of Seller's default. The Parties agree that a termination of this Agreement due to the failure of Seller to obtain a governmental approval or authorization for the Facility or Premises or a legal challenge brought by a third party to a governmental approval or authorization that has been granted for the Facility or Premises that causes prospective Lenders to refuse to provide financing for the construction of the Facility shall not be considered to be a default of Seller for purposes of this Section 11.4 only. Seller shall use commercially reasonable efforts and act consistent with the terms of this Agreement in obtaining all government approvals and authorizations and in participating in any legal challenge in an effort to sustain any governmental approval or authorization for the Facility or Premises. Further, Seller shall use commercially reasonable efforts to obtain financing. On or before the Effective Date, the Parties shall execute and record, in the appropriate real property records of the counties in which the Facility or Premises is situated, and any federal agency as applicable, a memorandum in the form of Exhibit 11.4 to provide constructive notice to third parties of Seller's agreements under this Section 11.4.

1.67 Termination Damages. If this Agreement is terminated as a result of an Event of Default by one of the Parties, termination damages shall be determined. The amount of termination damages shall be calculated by the non-defaulting Party within a reasonable period after termination of the Agreement. Amounts owed pursuant to this section shall be due within

five Business Days after the non-defaulting Party gives the defaulting Party notice of the amount due. The non-defaulting Party shall under no circumstances be required to account for or otherwise credit or pay the defaulting Party for economic benefits accruing to the non-defaulting Party as a result of the defaulting Party's default.

1.68 Duty/Right to Mitigate. Each Party agrees that it has a duty to mitigate damages and covenants that it will use commercially reasonable efforts to minimize any damages it may incur as a result of the other Party's performance or non-performance hereof. "Commercially reasonable efforts": (a) by Seller shall include requiring Seller to (i) use commercially reasonable efforts to maximize the price for Net Output received by Seller from third parties, including entering into an enabling agreement with, or being affiliated with, one or more power marketers of nationally recognized standing to market such Net Output (and associated Green Tags) not purchased or accepted by PacifiCorp (only during a period PacifiCorp is in default) and (ii) offering to sell to PacifiCorp (prior to selling to any third party) the Green Tags associated with such Net Output at the Green Tag Price Component, in each case, only to the extent any of the foregoing actions are permitted under Requirements of Law and the Interconnection Agreement; and (b) by PacifiCorp shall include requiring PacifiCorp to use commercially reasonable efforts to minimize the price paid to third parties for energy purchased to replace Net Output (and associated Green Tags) not delivered by Seller as required hereunder.

1.69 Security. If this Agreement is terminated because of Seller's default, PacifiCorp may, in addition to pursuing any and all other remedies available at law or in equity, proceed against any security held by PacifiCorp in whatever form to reduce any amounts that Seller owes PacifiCorp arising from such default.

1.70 Cumulative Remedies. Except in circumstances in which a remedy provided for in this Agreement is described as a sole or exclusive remedy, the rights and remedies provided to a Party hereunder are cumulative and not exclusive of any rights or remedies of such Party.

SECTION 12 INDEMNIFICATION AND LIABILITY

1.71 Indemnities.

1.71.1 Indemnity by Seller. To the extent permitted by Requirements of Law and subject to Section 12.1.5, Seller shall release, indemnify and hold harmless PacifiCorp, its divisions, Affiliates, and each of its and their respective directors, officers, employees, agents, and representatives (collectively, the "PacifiCorp Indemnitees") against and from any and all losses, fines, penalties, claims, demands, damages, liabilities, actions or suits of any nature whatsoever (including legal costs and attorneys' fees, both at trial and on appeal, whether or not suit is brought) (collectively, "Liabilities") actually or allegedly resulting from, or arising out of, or in any way connected with, the performance by Seller of its obligations hereunder, or relating to the Facility or Premises, for or on account of injury, bodily or otherwise, to, or death of, or damage to, or destruction or economic loss of property of, any person or entity, excepting only to the extent such Liabilities as may be caused by the gross negligence or willful misconduct of any person or entity within the PacifiCorp Indemnitees. Seller shall be solely responsible for (and shall defend and hold PacifiCorp harmless against) any damage that may occur as a direct result of Seller's breach of the Generation Interconnection Agreement.

1.71.2 Indemnity by PacifiCorp. To the extent permitted by Requirements of Law and subject to Section 12.1.5, PacifiCorp shall release, indemnify and hold harmless Seller, its Affiliates, and each of its and their respective directors, officers, employees, agents, and representatives (collectively, the "Seller Indemnitees") against and from any and all Liabilities actually or allegedly resulting from, or arising out of, or in any way connected with, the performance by PacifiCorp of its obligations hereunder for or on account of (a) injury, bodily or otherwise, to, or death of, or (b) for damage to, or destruction or economic loss of property of, any person or entity within the Seller Indemnitees, excepting only to the extent such Liabilities as may be caused by the gross negligence or willful misconduct of any person or entity within the Seller Indemnitees.

1.71.3 Additional Cross Indemnity. Without limiting Sections 12.1.1 and 12.1.2, Seller shall release, indemnify and hold harmless the PacifiCorp Indemnitees from and against all Liabilities related to Net Output prior to its delivery by Seller at the Point of Delivery, and PacifiCorp shall release, indemnify and hold harmless the Seller Indemnitees from and against all Liabilities related to Net Output once delivered to PacifiCorp at the Point of Delivery as provided herein, except in each case to the extent such Liabilities are attributable to the gross negligence or willful misconduct or a breach of this Agreement by any member of the PacifiCorp Indemnitees or the Seller Indemnitees, respectively, seeking indemnification hereunder.

1.71.4 No Dedication. Nothing herein shall be construed to create any duty to, any standard of care with reference to, or any liability to any person not a Party. No undertaking by one Party to the other under any provision hereof shall constitute the dedication of PacifiCorp's facilities or any portion thereof to Seller or to the public, nor affect the status of PacifiCorp as an independent public utility corporation or Seller as an independent individual or entity.

1.71.5 Consequential Damages. EXCEPT TO THE EXTENT SUCH DAMAGES ARE INCLUDED IN ANY LIQUIDATED DAMAGES, DELAY DAMAGES, PACIFICORP AND SELLER COST TO COVER DAMAGES, SECTION 11.2.3 CAPACITY RIGHTS LOSS DAMAGES, INDEMNIFICATION FOR THIRD PARTY DAMAGES, OR OTHER SPECIFIED MEASURE OF DAMAGES EXPRESSLY PROVIDED FOR HEREIN, NEITHER PARTY SHALL BE LIABLE TO THE OTHER PARTY FOR SPECIAL, PUNITIVE, INDIRECT, EXEMPLARY OR CONSEQUENTIAL DAMAGES, WHETHER SUCH DAMAGES ARE ALLOWED OR PROVIDED BY CONTRACT, TORT (INCLUDING NEGLIGENCE), STRICT LIABILITY, STATUTE OR OTHERWISE.

SECTION 13 INSURANCE

1.72 Required Policies and Coverages. Without limiting any liabilities or any other obligations of Seller hereunder, Seller shall secure and continuously carry the insurance coverage specified on Exhibit 13 during the Term or longer period if specified in Exhibit 13.

SECTION 14 FORCE MAJEURE

1.73 Definition of Force Majeure. "Force Majeure" or "an event of Force Majeure" means an event that (a) is not reasonably anticipated as of the date hereof, (b) is not within the

reasonable control of the Party affected by the event, (c) is not the result of such Party's negligence or failure to act, and (d) could not be overcome by the affected Party's use of due diligence in the circumstances. Force Majeure includes, but is not restricted to, events of the following types (but only to the extent that such an event, in consideration of the circumstances, satisfies the tests set forth in the preceding sentence): acts of God; civil disturbance; sabotage; strikes; lock-outs; work stoppages; action or restraint by court order or public or government authority (as long as the affected Party has not applied for or assisted in the application for, and has opposed to the extent reasonable, such court or government action). Notwithstanding the foregoing, none of the following constitute Force Majeure: (i) Seller's ability to sell, or PacifiCorp's ability to purchase energy or capacity at a more advantageous price than is provided hereunder; (ii) the cost or availability of fuel or motive force to operate the Facility; (iii) economic hardship, including lack of money; (iv) any breakdown or malfunction of the Facility's equipment (including any serial equipment defect) that is not caused by an independent event of Force Majeure; (v) the imposition upon a Party of costs or taxes allocated to such Party under Section 5; (vi) delay or failure of Seller to obtain or perform any Required Facility Document unless due to a Force Majeure event; (vii) any delay, alleged breach of contract, or failure by the Network Service Provider or Interconnection Provider unless due to a Force Majeure event; (viii) maintenance upgrade or repair of any facilities or right of way corridors constituting part of or involving the Interconnection Facilities, whether performed by or for Seller, or other third parties (except for repairs made necessary as a result of an event of Force Majeure); (ix) Seller's failure to obtain, or perform under, the Generation Interconnection Agreement, or its other contracts and obligations to transmission owner, Network Service Provider or Interconnection Provider, unless due to a Force Majeure event; or (x) any event attributable to the use of Interconnection Facilities for deliveries of Net Output to any party other than PacifiCorp. Notwithstanding anything to the contrary herein, in no event will the increased cost of electricity, steel, labor, or transportation constitute an event of Force Majeure.

1.74 Suspension of Performance. Neither Party shall be liable for any delay or failure in its performance under this Agreement, nor shall any delay, failure, or other occurrence or event become an Event of Default, to the extent such delay, failure, occurrence or event is substantially caused by conditions or events of Force Majeure during the continuation of the event of Force Majeure, for the same number of days that the event of Force Majeure has prevailed, provided that:

(a) the Party affected by the Force Majeure, shall, within five days after the occurrence of the event of Force Majeure, give the other Party written notice describing the particulars of the event; and

(b) the suspension of performance shall be of no greater scope and of no longer duration than is required to remedy the effect of the Force Majeure; and

(c) the affected Party shall use diligent efforts to remedy its inability to perform.

1.75 Force Majeure Does Not Affect Other Obligations. No obligations of either Party that arose before the Force Majeure causing the suspension of performance or that arise after the cessation of the Force Majeure shall be excused by the Force Majeure.

1.76 Strikes. Notwithstanding any other provision hereof, neither Party shall be required to settle any strike, walkout, lockout or other labor dispute on terms which, in the sole judgment of the Party involved in the dispute, are contrary to the Party's best interests.

1.77 Right to Terminate. If a Force Majeure event prevents a Party from substantially performing its obligations hereunder for a period exceeding 180 consecutive days prior to the Commercial Operation Date or, after the Commercial Operation Date, for a period exceeding 210 consecutive days (despite the affected Party's effort to take all reasonable steps to remedy the effects of the Force Majeure with all reasonable dispatch), then the Party not affected by the Force Majeure event, with respect to its obligations hereunder, may terminate this Agreement by giving 10 days' prior notice to the other Party. Upon such termination, neither Party will have any liability to the other with respect to period following the effective date of such termination; provided, however, that this Agreement will remain in effect to the extent necessary to facilitate the settlement of all liabilities and obligations arising hereunder before the effective date of such termination.

SECTION 15 SEVERAL OBLIGATIONS

Nothing contained herein shall be construed to create an association, trust, partnership or joint venture or to impose a trust, partnership or fiduciary duty, obligation or liability on or between the Parties.

SECTION 16 CHOICE OF LAW

This Agreement shall be interpreted and enforced in accordance with the laws of the state of Utah, applying any choice of law rules that may direct the application of the laws of another jurisdiction.

SECTION 17 PARTIAL INVALIDITY

The Parties do not intend to violate any laws governing the subject matter hereof. If any of the terms hereof are finally held or determined to be invalid, illegal or void as being contrary to any applicable law or public policy, all other terms hereof shall remain in effect. The Parties shall use best efforts to amend this Agreement to reform or replace any terms determined to be invalid, illegal or void, such that the amended terms (a) comply with and are enforceable under applicable law, (b) give effect to the intent of the Parties in entering hereinto, and (c) preserve the balance of the economics and equities contemplated by this Agreement in all material respects.

SECTION 18 NON-WAIVER

No waiver of any provision hereof shall be effective unless the waiver is set forth in a writing that (a) expressly identifies the provision being waived, and (b) is executed by the Party waiving the provision. A Party's waiver of one or more failures by the other Party in the performance of any of the provisions hereof shall not be construed as a waiver of any other failure or failures, whether of a like kind or different nature.

**SECTION 19
GOVERNMENTAL JURISDICTION
AND AUTHORIZATIONS**

This Agreement is subject to the jurisdiction of those Governmental Authorities having control over either Party or this Agreement. During the Term, Seller shall maintain all Permits required, as applicable, for the construction, operation, or ownership of the Facility.

**SECTION 20
SUCCESSORS AND ASSIGNS**

1.78 Restriction on Assignments. Except as expressly provided in this Section 20, neither Party may assign this Agreement or any of its rights or obligations hereunder without the prior written consent of the other Party.

1.79 Permitted Assignments. Notwithstanding Section 20.1, either Party may, without the need for consent from the other Party (but with notice to the other Party, including the names of the assignees): (a) transfer, sell, pledge, encumber or assign this Agreement or the accounts, revenues or proceeds therefrom in connection with project financing for the Facility; (b) transfer or assign this Agreement to an Affiliate of such Party; or (c) transfer or assign this Agreement to any party succeeding to all or substantially all of the assets or generating assets of such Party (and, with respect to Seller, Seller shall be required to transfer or assign this Agreement to any party succeeding to all or substantially all of the assets of Seller); provided, however, that Seller shall not transfer, sell, encumber or assign this Agreement or any interest herein to any Affiliate of PacifiCorp without the prior written consent of PacifiCorp. Except with respect to collateral assignments for financing purposes, in every assignment permitted under this Section 20.2, including any assignment of this Agreement by PacifiCorp pursuant to the next sentence, the assignee must agree in writing to be bound by the terms and conditions hereof and must possess the same or similar experience, and possess the same or better creditworthiness, as the assignor. PacifiCorp may assign this Agreement in whole or in part without the consent of Seller to any person or entity in the event that PacifiCorp ceases to be a load-serving entity, in which event PacifiCorp shall be released from liability hereunder upon approval of PacifiCorp ceasing to be a load-serving entity by the Commission. The Party seeking to assign or transfer this Agreement shall be solely responsible for paying all costs of assignment.

**SECTION 21
ENTIRE AGREEMENT**

This Agreement supersedes all prior agreements, proposals, representations, negotiations, discussions or letters, whether oral or in writing, regarding the subject matter hereof. No modification hereof shall be effective unless it is in writing and executed by both Parties.

**SECTION 22
NOTICES**

1.80 Addresses and Delivery Methods. All notices, requests, statements or payments shall be made to the addresses set out below. In addition, copies of a notice of termination of this Agreement under Section 11.3 shall contain the information required by Section 11.3 and shall be sent to the then-current President and General Counsel of PacifiCorp. Notices required

to be in writing shall be delivered by letter, facsimile or other tangible documentary form. Notice by overnight mail or courier shall be deemed to have been given on the date and time evidenced by the delivery receipt. Notice by hand delivery shall be deemed to have been given when received or hand delivered. Notice by facsimile is effective as of transmission to each and all of the telefacsimile numbers provided below for a Party, but must be followed up by notice by registered mail or overnight carrier to be effective. Notice by overnight mail shall be deemed to have been given the Business Day after it is sent, if sent for next day delivery to a domestic address by a recognized overnight delivery service (e.g., Federal Express or UPS). Notice by certified or registered mail, return receipt requested, shall be deemed to have been given upon receipt.

To Seller:

Pavant Solar II LLC
c/o juwi solar Inc.
1710 29th Street, Suite 1068
Boulder, Colorado 80301
Attn: Director, Project Management and
Engineering
Telefacsimile (303) 442-1981

with a copy to:

juwi solar Inc.
1710 29th Street, Suite 1068
Boulder, Colorado 80301
Attn: General Counsel
Telefacsimile (303) 442-1981

To PacifiCorp:

PacifiCorp
825 NE Multnomah, Suite 2000
Portland, Oregon 97232- 2315
Attn: Director, Origination
Telefacsimile (503) 813-6260

with a copy to:

PacifiCorp
825 NE Multnomah, Suite 600
Portland, Oregon 97232- 2315
Attn: Manager of Contract Administration, C&T
Telefacsimile (503) 813-6291

with a copy to:

PacifiCorp Legal Department
825 NE Multnomah, Suite 2000
Portland, Oregon 97232- 2315
Attn: Assistant General Counsel
Telefacsimile (503) 813-6761

and termination notices to PacifiCorp: PacifiCorp Legal Department
825 NE Multnomah, Suite 2000
Portland, Oregon 97232- 2315
Attn: General Counsel

and to: Rocky Mountain Power Legal Department
201 S. Main Street, Suite 2300
Salt Lake City, Utah 84111
Attn: General Counsel Attn: General Counsel

1.81 Changes of Address. The Parties may change any of the persons to whom notices are addressed, or their addresses, by providing written notice in accordance with this section.

SECTION 23 CONFIDENTIALITY

1.82 Confidential Business Information. The following constitutes "Confidential Business Information," whether oral or written: (a) the Parties' proposals and negotiations concerning this Agreement, made or conducted prior to the Effective Date, (b) the actual charges billed to PacifiCorp hereunder, and (c) any information delivered by PacifiCorp to Seller prior to the Effective Date relating to the market prices of energy or Green Tags and methodologies for their determination or estimation. Seller and PacifiCorp each agree to hold such Confidential Business Information wholly confidential, except as otherwise expressly provided in this Agreement. "Confidential Business Information" shall not include information that (x) is in or enters the public domain through no fault of the Party receiving such information, or (y) was in the possession of a Party prior to the Effective Date, other than through delivery thereof as specified in subsections (a) and (c) above. A Party providing any Confidential Business Information under this Agreement shall clearly mark all pages of all documents and materials to be treated as Confidential Business information with the term "Confidential" on the front of each page, document or material. If the Confidential Business Information is transmitted by electronic means the title or subject line shall indicate the information is Confidential Business Information. All Confidential Business Information shall be maintained as confidential, pursuant to the terms of Section 23, for a period of two years from the date it is received by the receiving Party unless otherwise agreed to in writing by the Parties.

1.83 Duty to Maintain Confidentiality. Each Party agrees not to disclose Confidential Business Information to any other person (other than its Affiliates, accountants, auditors, counsel, consultants, lenders, prospective lenders, employees, officers and directors), without the prior written consent of the other Party, provided that: (a) either Party may disclose Confidential Business Information, if and to the extent such disclosure is required (i) by Requirements of Law, (ii) in order for PacifiCorp to receive regulatory recovery of expenses related to this Agreement, (iii) pursuant to an order of a court or regulatory agency, or (iv) in order to enforce this Agreement or to seek approval hereof, and (b) notwithstanding any other provision hereof, PacifiCorp may in its sole discretion disclose or otherwise use for any purpose in its sole discretion the Confidential Business Information described in Sections 23.1(b) or 23.1(c). In the event a Party is required by Requirements of Law to disclose Confidential Business Information, such Party shall to the extent possible promptly notify the other Party of the obligation to disclose such information.

1.84 PacifiCorp Regulatory Compliance. The Parties acknowledge that PacifiCorp is required by law or regulation to report certain information that is or could otherwise embody Confidential Business Information from time to time. Such reports include models, filings, reports of PacifiCorp's net power costs, general rate case filings, power cost adjustment mechanisms, FERC-required reporting such as those made on FERC Form 1, Form 12, or Form 714, market power and market monitoring reports, annual state reports that include resources and loads, integrated resource planning reports, reports to entities such as NERC, WECC, Pacific Northwest Utility Coordinating Committee, WREGIS, or similar or successor organizations, forms, filings, or reports, the specific names of which may vary by jurisdiction, along with supporting documentation. Additionally, in regulatory proceedings in all state and federal jurisdictions in which it does business, PacifiCorp will from time to time be required to produce Confidential Business Information. PacifiCorp may use its business judgment in its compliance with all of the foregoing and the appropriate level of confidentiality it seeks for such disclosures. PacifiCorp may submit Confidential Business Information in regulatory proceedings without notice to Seller.

1.85 Irreparable Injury; Remedies. Each Party agrees that violation of the terms of this Section 23 constitutes irreparable harm to the other, and that the harmed Party may seek any and all remedies available to it at law or in equity, including injunctive relief.

1.86 News Releases and Publicity. Except as otherwise provided in Section 6.14, before either Party issues any news release or publicly distributed promotional material regarding the Facility that mentions the Facility, such Party shall first provide a copy thereof to the other Party for its review and approval. Any use of either Party's name in such news release or promotional material must adhere to such Party's publicity guidelines then in effect; any use of Berkshire Hathaway's name requires PacifiCorp's prior written consent.

SECTION 24 DISAGREEMENTS

1.87 Negotiations. The Parties shall attempt in good faith to resolve all disputes arising out of, related to or in connection with this Agreement promptly by negotiation, as follows. Any Party may give the other Party written notice of any dispute not resolved in the normal course of business. Executives of both Parties at levels one level above the personnel who have previously been involved in the dispute shall meet at a mutually acceptable time and place within 10 days after delivery of such notice, and thereafter as often as they reasonably deem necessary, to exchange relevant information and to attempt to resolve the dispute. If the matter has not been resolved within 30 days after the referral of the dispute to such senior executives, or if no meeting of such senior executives has taken place within 15 days after such referral, either Party may initiate any legal remedies available to the Party. All negotiations pursuant to this clause are confidential.

1.88 Mediation; Technical Expert.

1.88.1 Mediation. If the dispute is not resolved within 30 days after the referral of the dispute to senior executives, or if no meeting of senior executives has taken place within 15 days after such referral, either Party may request that the matter be submitted to nonbinding mediation. If the other Party agrees, the mediation will be conducted in accordance with the

Construction Industry Arbitration Rules and Mediation Procedures (Including Procedures for Large, Complex Construction Disputes) of the AAA, as amended and effective on the date a Party requests mediation (the "Mediation Procedures").

(a) The Party requesting the mediation, may commence the mediation process with AAA by notifying AAA and the other Party in writing ("Mediation Notice") of such Party's desire that the dispute be resolved through mediation, including therewith a copy of the Dispute Notice and the response thereto, if any, and a copy of the other Party's written agreement to such mediation.

(b) The mediation shall be conducted through, by and at the office of AAA located in Salt Lake City, Utah.

(c) The mediation shall be conducted by a single mediator. The Parties may select any mutually acceptable mediator. If the Parties cannot agree on a mediator within five days after the date of the Mediation Notice, then the AAA's arbitration administrator shall send a list and resumes of three available mediators to the Parties, each of whom shall strike one name, and the remaining person shall be appointed as the mediator. If more than one name remains, either because one or both Parties have failed to respond to the AAA's arbitration administrator within five days after receiving the list or because one or both Parties have failed to strike a name from the list or because both Parties strike the same name, the AAA's arbitration administrator will choose the mediator from the remaining names. If the designated mediator shall die, become incapable or, unwilling to, or unable to serve or proceed with the mediation, a substitute mediator shall be appointed in accordance with the selection procedure described above in this Section 24.2.1, and such substitute mediator shall have all such powers as if he or she has been originally appointed herein.

(d) The mediation shall consist of one or more informal, nonbinding meetings between the Parties and the mediator, jointly and in separate caucuses, out of which the mediator will seek to guide the Parties to a resolution of the Dispute. The mediation process shall continue until the resolution of the dispute, or the termination of the mediation process pursuant to Section 24.2.1(f). The costs of the mediation, including fees and expenses, shall be borne equally by the Parties.

(e) All verbal and written communications between the Parties and issued or prepared in connection with this Section 24.1 shall be deemed prepared and communicated in furtherance, and in the context, of dispute settlement, and shall be exempt from discovery and production, and shall not be admissible in evidence (whether as admission or otherwise) in any litigation or other proceedings for the resolution of the dispute.

(f) The initial mediation meeting between the Parties and the mediator shall be held within 20 days after the Mediation Notice. Either Party may terminate the mediation process upon or after the earlier to occur of (i) the failure of the initial mediation meeting to occur within 20 days after the date of the Mediation Notice, (ii) the passage of 30 days after the date of the Mediation Notice without the dispute having been resolved, or (iii) such time as the mediator makes a finding that there is no possibility of resolution through mediation.

(g) All deadlines specified in this Section 24.2.1 may be extended by mutual agreement.

1.88.2 Technical Expert. If the dispute regards (a) whether or not Commercial Operation has been achieved, or (b) the disputed amount of any invoice, the Parties may, in lieu of mediation, have such dispute resolved pursuant to this Section 24.2.2. Any such dispute will be determined by an independent technical expert, who shall be a mutually acceptable third party with training and experience in the disciplines relevant to the matters with respect to which such person is called upon to provide a certification, evaluation or opinion (the "Technical Expert"), which determination shall be (x) made in accordance with the Construction Industry Arbitration Rules and Mediation Procedures (Including Procedures for Large, Complex Construction Disputes) of the AAA, as amended and effective on the date a Party provides notice of its intent to submit the dispute to a technical expert, and (y) binding upon the Parties.

(a) Either Party may commence the technical dispute process with AAA by notifying AAA and the other Party in writing ("Technical Dispute Notice") of such Party's desire that the dispute be resolved through a determination by a technical expert.

(b) The determination shall be conducted by a sole Technical Expert. The Parties may select any mutually acceptable Technical Expert. If the Parties cannot agree on a Technical Expert within five days after the date of the Technical Dispute Notice, then the AAA's arbitration administrator shall send a list and resumes of three available technical experts meeting the qualifications set forth in Section 24.2.2 to the Parties, each of whom shall strike one name, and the remaining person shall be appointed as the Technical Expert. If more than one name remains, either because one or both Parties have failed to respond to the AAA's arbitration administrator within five days after receiving the list or because one or both Parties have failed to strike a name from the list or because both Parties strike the same name, the AAA's arbitration administrator will choose the Technical Expert from the remaining names. If the designated Technical Expert shall die, become incapable or, unwilling to, or unable to serve or proceed with the determination, a substitute technical expert shall be appointed in accordance with the selection procedure described above, and such substitute Technical Expert shall have all such powers as if he or she has been originally appointed herein.

(c) Within 30 days of the appointment of the Technical Expert pursuant to the foregoing sub-section, each Party shall submit to the Technical Expert a written report containing its position with respect to the dispute, and arguments therefor together with supporting documentation and calculations. Discovery shall be limited to Facility documentation relating to the disputed matter. Within 60 days from receipt of such submissions, the Technical Expert shall select one or the other Party's position with respect to the dispute, whereupon such selection shall be a binding determination upon the Parties for all purposes hereof. The costs of the determination by the Technical Expert of any dispute, including fees and expenses, shall be borne by the Party whose position was not selected by the Technical Expert. If the Technical Expert fails to render a decision within 90 days from receipt of each Party's submissions, either Party may initiate litigation in accordance with the provisions herein.

(d) All verbal and written communications between the Parties and issued or prepared in connection with this Section 24.2.2 shall be deemed prepared and

communicated in furtherance, and in the context, of dispute settlement, and shall be exempt from discovery and production, and shall not be admissible in evidence (whether as admission or otherwise) in any litigation or other proceedings for the resolution of the dispute.

(e) All deadlines specified in this Section 24.2.2 may be extended by mutual agreement of the Parties.

1.89 Place of Contract Formation; Choice of Forum. Seller and PacifiCorp acknowledge and agree that this Agreement has been made and entered into as of the date executed by both Parties in Salt Lake City, Utah. Each Party irrevocably consents and agrees that any legal action or proceeding arising out of this Agreement or the actions of the Parties leading up to the Agreement shall be brought exclusively in the United States District Court for the District of Utah in Salt Lake City, Utah, or if such court does not have jurisdiction, in the 3rd Judicial District (Salt Lake County) Court of the state of Utah. By execution and delivery hereof, each Party (a) accepts the exclusive jurisdiction of such court and waives any objection that it may now or hereafter have to the exercise of personal jurisdiction by such court over each Party for the purpose of any proceeding related to this Agreement, (b) irrevocably agrees to be bound by any final judgment (after any and all appeals) of any such court arising out of such documents or actions, (c) irrevocably waives, to the fullest extent permitted by law, any objection that it may now or hereafter have to the laying of venue of any suit, action or proceedings arising out of such documents brought in such court (including any claim that any such suit, action or proceeding has been brought in an inconvenient forum) in connection herewith, and), (d) agrees that service of process in any such action may be effected by mailing a copy thereof by registered or certified mail, postage prepaid, to such Party at its address as set forth herein, and (e) agrees that nothing herein shall affect the right to effect service of process in any other manner permitted by law.

1.90 Settlement Discussions. No statements of position or offers of settlement made in the course of the dispute process described in this section will be offered into evidence for any purpose in any litigation between the Parties, nor will any such statements or offers of settlement be used in any manner against either Party in any such litigation. Further, no such statements or offers of settlement shall constitute an admission or waiver of rights by either Party in connection with any such litigation. At the request of either Party, any such statements and offers of settlement, and all copies thereof, shall be promptly returned to the Party providing the same.

1.91 Waiver of Jury Trial. EACH PARTY KNOWINGLY, VOLUNTARILY, INTENTIONALLY AND IRREVOCABLY WAIVES THE RIGHT TO A TRIAL BY JURY IN RESPECT OF ANY LITIGATION BASED ON THIS AGREEMENT, OR ARISING OUT OF, UNDER OR IN CONNECTION WITH THIS AGREEMENT AND ANY AGREEMENT EXECUTED OR CONTEMPLATED TO BE EXECUTED IN CONJUNCTION WITH THIS AGREEMENT, OR ANY COURSE OF CONDUCT, COURSE OF DEALING, STATEMENTS (WHETHER VERBAL OR WRITTEN) OR ACTIONS OF ANY PARTY HERETO. THIS PROVISION IS A MATERIAL INDUCEMENT TO EACH OF THE PARTIES FOR ENTERING HEREINTO. EACH PARTY HEREBY WAIVES ANY RIGHT TO CONSOLIDATE ANY ACTION, PROCEEDING OR COUNTERCLAIM ARISING OUT OF OR IN CONNECTION WITH THIS AGREEMENT OR ANY OTHER AGREEMENT

EXECUTED OR CONTEMPLATED TO BE EXECUTED IN CONJUNCTION WITH THIS AGREEMENT, OR ANY MATTER ARISING HEREUNDER OR THEREUNDER, WITH ANY PROCEEDING IN WHICH A JURY TRIAL HAS NOT OR CANNOT BE WAIVED.

1.92 Specific Performance. Each Party shall be entitled to seek and obtain a decree compelling specific performance or granting injunctive relief with respect to, and shall be entitled, to enjoin any actual or threatened breach of any material obligation of the other Party hereunder. The Parties agree that specific performance (including temporary and preliminary relief) and injunctive relief are proper in the event of any actual or threatened breach of any material obligation of the other Party hereunder, and that any liability limits contained herein shall not operate to limit the exercise of PacifiCorp's remedies in equity to cause Seller to perform its obligations hereunder. Seller agrees that it will not assert as a defense to PacifiCorp's action for specific performance of, or injunctive relief relating to, Seller's obligations hereunder that the amounts payable or paid by Seller in respect of liquidated damages constitute an adequate remedy for the breach of such obligation, and Seller hereby conclusively waives such defense. Seller shall at all times during the Term, own, lease, control, hold in its own name or be signatory to (as the case may be) all assets and Required Facility Documents relating to the Facility to the extent necessary to prevent a material adverse effect on PacifiCorp's right to specific performance or injunctive relief.

IN WITNESS WHEREOF, the Parties have caused this Agreement to be executed in their respective names as of the date last written below.

PAVANT SOLAR II LLC

PACIFICORP

By: _____
Name: Michael Martin

By: _____
Name: Bruce Griswold

Title: President

Title: Director, Short Term Origination and QF Contracts

Date: _____

Date: _____

EXHIBIT A

ESTIMATED MONTHLY OUTPUT

The following is the Expected Energy for the Facility. The Expected Energy includes losses as characterized in PVSYST, estimated outages as outlined in Section 6.5.5, as well as other losses due to availability, wind stow, ac-side collection, transformers, substation, and no-load/overnight losses

EXPECTED ENERGY - FIRST FULL CONTRACT YEAR	
PERIOD	
January	
February	
March	
April	
May	
June	
July	
August	
September	
October	
November	
December	
First Year Total	

EXPECTED ENERGY - ANNUAL REDUCTION	
PERIOD	EXPECTED ENERGY (MWh)
Year 0-1	
Year 1-2	
Year 2-3	
Year 3-4	
Year 4-5	
Year 5-6	
Year 6-7	
Year 7-8	
Year 8-9	
Year 9-10	
Year 10-11	
Year 11-12	
Year 12-13	
Year 13-14	
Year 14-15	
Year 15-16	
Year 16-17	
Year 17-18	
Year 18-19	
Year 19-20	

Under separate cover, Seller shall also provide to PacifiCorp one (1) electronic and hard copy of the solar plant performance estimation report using PVSYST or a comparable solar performance modeling program. Report will contain estimated hourly kW generation output in kWh/h for the site and Facility. Note additional losses related to availability, wind stow, ac-side collection, transformers, substation, and no-load/overnight losses, are considered in addition to PVSYST.

Upon Commercial Operations, Seller shall provide updated Exhibit A and PVSYST if there are any material changes based on completed construction.

EXHIBIT B

NERC EVENT TYPES

Event Type	Description of Outages
U1 ¹	<u>Unplanned (Forced) Outage—Immediate</u> – An outage that requires immediate removal of a unit from service, another outage state or a Reserve Shutdown state. This type of outage results from immediate mechanical/electrical/hydraulic control systems trips and operator-initiated trips in response to unit alarms.
U2 ¹	<u>Unplanned (Forced) Outage—Delayed</u> – An outage that does not require immediate removal of a unit from the in-service state but requires removal within six (6) hours. This type of outage can only occur while the unit is in service.
U3 ¹	<u>Unplanned (Forced) Outage—Postponed</u> – An outage that can be postponed beyond six hours but requires that a unit be removed from the in-service state before the end of the next weekend. This type of outage can only occur while the unit is in service.
SF ¹	<u>Startup Failure</u> – An outage that results from the inability to synchronize a unit within a specified startup time period following an outage or Reserve Shutdown. A startup period begins with the command to start and ends when the unit is synchronized. An SF begins when the problem preventing the unit from synchronizing occurs. The SF ends when the unit is synchronized or another SF occurs.
MO	<u>Maintenance Outage</u> – An outage that can be deferred beyond the end of the next weekend, but requires that the unit be removed from service before the next planned outage. (Characteristically, a MO can occur any time during the year, has a flexible start date, may or may not have a predetermined duration and is usually much shorter than a PO.)
ME	<u>Maintenance Outage Extension</u> – An extension of a maintenance outage (MO) beyond its estimated completion date. This is typically used where the original scope of work requires more time to complete than originally scheduled. Do not use this where unexpected problems or delays render the unit out of service beyond the estimated end date of the MO.
PO	<u>Planned Outage</u> – An outage that is scheduled well in advance and is of a predetermined duration, lasts for several weeks and occurs only once or twice a year. (Boiler overhauls, Solar Array replacement or inspections are typical planned outages.)
PE	<u>Planned Outage Extension</u> – An extension of a planned outage (PO) beyond its estimated completion date. This is typically used where the original scope of work requires more time to complete than originally scheduled. Do not use this where unexpected problems or delays render the unit out of service beyond the estimated end date of the PO.

EXHIBIT C

EXAMPLE OF CALCULATION OF DELAY DAMAGES

For the purposes of this example only, assume the following:

(Note: These assumptions are illustrative only. Actual terms are as defined in this Agreement)

Expected Energy = 652,746 MWhs

PacifiCorp's Cost to Cover = as set forth in the table below

Scheduled Commercial Operation Date: April 1, 2011

Date on which Delay Damages begin to accrue: April 1, 2011

Actual Commercial Operation Date: June 1, 2011

	A	B
	PacifiCorp's Cost to Cover	Delay Damages
DATE		(A X 652,746 /365)
Saturday April 2, 2011	\$14.15	\$25,305.08
Sunday April 3, 2011	\$20.90	\$37,376.41
Monday April 4, 2011	\$13.90	\$24,858.00
Tuesday April 5, 2011	\$16.15	\$28,881.78
Wednesday April 6, 2011	\$16.15	\$28,881.78
Thursday April 7, 2011	\$14.90	\$26,646.34
Friday April 8, 2011	\$17.15	\$30,670.12
Saturday April 9, 2011	\$23.15	\$41,400.19
Sunday April 10, 2011	\$19.90	\$35,588.07
Monday April 11, 2011	\$11.90	\$21,281.31
Tuesday April 12, 2011	\$12.90	\$23,069.65
Wednesday April 13, 2011	\$12.90	\$23,069.65
Thursday April 14, 2011	\$20.90	\$37,376.41
Friday April 15, 2011	\$20.40	\$36,482.24
Saturday April 16, 2011	\$20.00	\$35,766.90
Sunday April 17, 2011	\$20.00	\$35,766.90
Monday April 18, 2011	\$20.00	\$35,766.90
Tuesday April 19, 2011	\$20.00	\$35,766.90
Wednesday April 20, 2011	\$20.00	\$35,766.90
Thursday April 21, 2011	\$20.00	\$35,766.90
Friday April 22, 2011	\$20.00	\$35,766.90
Saturday April 23, 2011	\$20.00	\$35,766.90
Sunday April 24, 2011	\$20.00	\$35,766.90
Monday April 25, 2011	\$20.00	\$35,766.90
Tuesday April 26, 2011	\$20.00	\$35,766.90

Wednesday April 27, 2011	\$20.00	\$35,766.90
Thursday April 28, 2011	\$20.00	\$35,766.90
Friday April 29, 2011	\$20.00	\$35,766.90
Saturday April 30, 2011	\$20.00	\$35,766.90
Sunday May 1, 2011	\$20.00	\$35,766.90
Monday May 2, 2011	\$20.00	\$35,766.90
Tuesday May 3, 2011	\$20.00	\$35,766.90
Wednesday May 4, 2011	\$20.00	\$35,766.90
Thursday May 5, 2011	\$20.00	\$35,766.90
Friday May 6, 2011	\$20.00	\$35,766.90
Saturday May 7, 2011	\$20.00	\$35,766.90
Sunday May 8, 2011	\$20.00	\$35,766.90
Monday May 9, 2011	\$20.00	\$35,766.90
Tuesday May 10, 2011	\$20.00	\$35,766.90
Wednesday May 11, 2011	\$20.00	\$35,766.90
Thursday May 12, 2011	\$20.00	\$35,766.90
Friday May 13, 2011	\$20.00	\$35,766.90
Saturday May 14, 2011	\$20.00	\$35,766.90
Sunday May 15, 2011	\$20.00	\$35,766.90
Monday May 16, 2011	\$20.00	\$35,766.90
Tuesday May 17, 2011	\$20.00	\$35,766.90
Wednesday May 18, 2011	\$20.00	\$35,766.90
Thursday May 19, 2011	\$20.00	\$35,766.90
Friday May 20, 2011	\$20.00	\$35,766.90
Saturday May 21, 2011	\$20.00	\$35,766.90
Sunday May 22, 2011	\$20.00	\$35,766.90
Monday May 23, 2011	\$20.00	\$35,766.90
Tuesday May 24, 2011	\$20.00	\$35,766.90
Wednesday May 25, 2011	\$20.00	\$35,766.90
Thursday May 26, 2011	\$20.00	\$35,766.90
Friday May 27, 2011	\$20.00	\$35,766.90
Saturday May 28, 2011	\$20.00	\$35,766.90
Sunday May 29, 2011	\$20.00	\$35,766.90
Monday May 30, 2011	\$20.00	\$35,766.90
Tuesday May 31, 2011	\$20.00	\$35,766.90
Total Delay Damages		\$2,066,164.63

EXHIBIT D

START-UP TESTING

[NTD Test protocol may be supplemented with additional testing procedures as negotiated in the EPC contract for the Project]

1. Test Plan Overview

1.1. Introduction

A completed Test Plan will be required as part of the commissioning process for the Pavant Solar Project. It is critical for all projects to coordinate the efforts of the EPC Contractor, owner and vendors. To this end, this plan is intended to aid the Project Site management team in achieving the goal of providing the Owner with a high quality end product to be operated efficiently over its intended life.

1.2. Purpose

Electrical testing is done to gain confidence that the system can be energized safely and will operate reliably.

Consolidating all of the project's electrical testing into one document allows a single reference to be shared among all the testing stakeholders. Schedules and expectations will be more easily managed if everyone on a site knows not only what they are doing, but what others are doing as well.

1.3. Safety

JSI considers safety and quality installation in the highest regard. The two are not mutually exclusive but key elements of a successful project. The safety of all jobsite personnel is the top priority of JSI. This test plan should never be used as justification for not following safety protocols.

It must be noted that this Test Plan does not cover all possible items that may arise while testing a project. Should the tester encounter a condition not specifically identified herein, and is unable to evaluate the quality of the installation, the tester should document the concern, seek outside assistance to help resolve the concern and determine the method of how to best resolve and capture the resolution.

All personnel associated with the testing of this project shall be adequately trained and supervised in construction jobsite safety. Any personnel performing tests shall be familiar with safety procedures especially those unique to solar projects. Additionally, all safety requirements specified by equipment or other material suppliers and vendors must be followed.

All environmental conditions such as ambient temperature, humidity, working environment (dust, mud, insects, surface water, etc.) shall be considered as crucial safety factor part of the testing plan.

For all testing on exposed and energized equipment, proper PPE must be worn by all participants and the buddy system shall be used. A minimum of a hard hat, safety glasses, over the ankle shoes, flame retardant cotton pants and shirt, and leather protectors & dielectric gloves will be worn for all testing on exposed and energized parts. Additional PPE may be required as directed by NFPA 70E and the results of the arc flash analysis.

1.4. Scope

The electrical test plan for this project is comprised of the following elements:

- DC electrical tests
- Medium voltage AC electrical tests (600-35,000Vac)
- Low voltage AC electrical tests (0-600Vac)
- Grounding resistance tests
- Monitoring/SCADA tests

1.5. Purpose

It is the intent of this plan to verify that all work has been performed properly and tested so that the solar facility is ready to commence initial generation.

1.6. Summary of Test Plan

The Test Plan described herein is intended to assist the field installation supervisory personnel in performing all testing required prior to the start-up and commissioning of the solar facility. The primary goal is to verify through testing that:

- The work performed provides for a high quality installation
- The construction of the project is in accordance with the contract documents
- Overall installation of the project meets applicable construction safety codes and standards
- All electrical installations are ready for start-up

2. General

2.1. Subcontractor requirements

The Owner or JSI may require that certain tests be done in its presence or in the presence of the equipment manufacturer's representative.

The Owner or JSI may, at its own expense, perform additional testing at any time, provided all appropriate safety measures are taken prior to any such testing.

Connections and terminations should not be made without properly executing the applicable portions of the testing plan.

Test procedures, equipment, temporary circuits, etc., shall be designed and utilized to minimize danger to testing technicians and surrounding personnel (i.e., current transformer temporary test circuits utilizing alligator clips will not be permitted). Furnish and use appropriately rated safety devices such as rubber gloves and blankets, provide protective screens and barriers, yellow or red tape, and danger signs, to adequately protect and warn all personnel in the vicinity of the tests.

Provide full and comprehensive reports of all testing to JSI. In the case where problems are experienced, notify JSI for directions and if directed, perform corrective action to resolve issue(s) and provide record of such corrections in a report.

2.2. Applicable Standards

American National Standards Institute (ANSI)
American Society for Testing and Materials (ASTM)
Insulated Cable engineers association (ICEA)
National Electrical Code (NEC)
National Electrical Manufacturers Association (NEMA)
The Institute of Electrical and Electronics Engineers, Inc. (IEEE)
International Electrical Testing Association (NETA)
National Electrical Safety Code (NESC)

2.3. Definitions

Dielectric Withstand Test (Hipot) - A standard test voltage is applied (below the established Breakdown Voltage) and the resulting leakage current is monitored. The leakage current must be below a preset limit or the test is considered to have failed. This test is non-destructive.

Installation – Performed by the subcontractor and is considered fully installed once all of the following items have been completed:

- Physically placing, fastening, or securing all equipment in accordance with the Construction Drawings;
- Testing the equipment per the QA Plan;
- Making all terminations described in the Construction Drawings;
- Labeling (if necessary); and
- Locking and tagging the equipment

Insulation Resistance Test (IRT) - This test is used to provide a quantifiable resistance value for all of a product's insulation. The test voltage is applied in the same fashion as a standard Hipot test, but is specified to be Direct Current (DC). The voltage and measured current value are used to calculate the resistance of the insulation.

Quality Assurance (QA) – The checkpoints used by EPC Contractor to ensure the construction and installation methods are consistent with the quality expected by EPC Contractor. QA may include independent checks by qualified personnel of the work done by others and is intended to ensure quality workmanship.

Quality Control (QC) – Is the act of documenting Quality Assurance through the either visual or quantitative review of material received and work performed by the EPC Contractor thus ensuring the solar facility is built according to the construction drawings and specifications.

Testing – Carrying-out and documenting the civil and electrical verification tests required by EPC Contractor. Test results that do not meet required thresholds or values will trigger adjustment or changes to the installation process or will identify installation items that need to be addressed. Examples of tests include:

- Continuity

- Megger testing (conductor insulation resistance to ground)
- Open circuit voltage
- Short circuit current
- Polarity
- Relay functional tests

2.4. Applicable Documents

- Project specifications and data sheets.
- Construction drawings.
- Vendor drawings, test certificates.
- Vendor instructions for testing.
- Installation drawings, instruction manuals, standard details, and work procedures

3. Grounding

General Notes
<ul style="list-style-type: none"> • All testing shall be done only after grounding is buried and terminated • All testing shall be done in dry conditions. Dry conditions are defined as no fewer than 3 days after measureable (>1/4") rain. • To pass all ground resistance tests the resistance must be less than or equal to 3 ohms. • If the test leads need to be extended when measuring resistance, subtract out the resistance of the extensions from the total resistance.
Instruments Required
<ul style="list-style-type: none"> • Vanguard 100 amp, or equivalent, for point-to-point checks. • Megger 100 amp, or equivalent, for ground grid resistance test. • Fluke 1625, or equivalent, for soil resistance test.

3.1. Fence Ground Continuity

- 3.1.1. At fence grounding locations along the fence line measure and record the resistance between the fence and the closest grounded location within the fence (e.g. an array post).
- 3.1.2. At gate grounding locations measure and record the resistance between the fence and a grounded location within the fence (e.g. an array post).

3.2. Verify Ground Grid Resistance

3.2.1. DC Field

- 3.2.1.1. For each combiner box measure and record the resistance to the combiner boxes to the North and/or South.

- 3.2.1.2. For each interior ground rod measure and record the resistance between it and the ground rods immediately to the North and/or South.
- 3.2.1.3. Measure and record the resistance between the bonding jumper on the second motor of each drive line to the jumper on the second motor immediately to the North and South on adjacent drive lines.
- 3.2.1.4. Measure and record the resistance from the ground wire at the end of each cable tray to the ground well at power station it feeds.
- 3.2.1.5. Within each power station make 4 spot check measurements between the cable trays and the bonding jumper on a post farthest from the cable tray on the same drive line and record the resistance.

3.2.2. Power Station

- 3.2.2.1. Measure and record the resistance between each pair of power station ground test wells to all adjacent pair of power stations ground test well.
- 3.2.2.2. Measure and record the resistance between the grounding terminals of the Power Station transformer and the closest test well to the Power Station.
- 3.2.2.3. Measure and record the resistance between the ground attachment to power station structural steel and the closest test well to the power station.

3.2.3. Medium Voltage AC Interconnection Equipment

- 3.2.3.1. Measure and record the resistance from and exposed ground point within the interconnection equipment to the nearest ground adjacent to the interconnection equipment.

4. DC Field Electrical Tests

Safety Notes
<ul style="list-style-type: none"> • Before the testing begins: Confirm conductors are clear and will remain clear of personnel and free from contact with grounded surfaces • All testers must wear leather gloves
General Notes
<ul style="list-style-type: none"> • All testing shall be done only after grounding is buried and terminated • All IRT testing will take place at a temperature above the dew point
Instruments Required
<ul style="list-style-type: none"> • Calibrated 1-kV IRT tester • juwi DC String Tester

4.1. Array Feeder Polarity and Circuit Location Confirmation

- 4.1.1. Once the Array feeders have been fully installed with connectors at the module end, label both ends of the conductors with the appropriate permanent ID. Strip the conductor at the DCB end and terminate it in the DCB.
- 4.1.2. Testing shall be performed with two people communicating with 2 way radios between the array and the DCB. The person at the array will use a piece of copper wire to create an electrical connection between the connector and a grounded surface to check the continuity of (“ring out”) the array feeders to ground to confirm the correct polarity and array circuit.

4.2. DCB Feeder Polarity and Circuit Location Confirmation

- 4.2.1. Once the DCB feeders have been installed, check their continuity (“ring them out”) to ground to confirm the polarity and termination location in the Inverter DC termination cabinet.
- 4.2.2. Label the conductors with the appropriate permanent ID label but DO NOT terminate them.

4.3. DCB Feeder IRT Test

Note: All other conductors except the one being tested are to be connected to ground.

- 4.3.1. Testing shall not begin until all the conductors have been cut, stripped and labeled.
- 4.3.2. To test individual conductors, isolate conductor on both ends and ensure all other conductors are connected to ground. Connect one lead of the tester to the ground terminal and the other lead to the conductor to be tested.
- 4.3.3. Apply test voltage to the cable as specified in Table 1 below. Record the data from the tester on test form.
- 4.3.4. Terminate the DCB feeders to their corresponding locations at both the Inverter and in the DCB.
- 4.3.5. DO NOT close the fuse holders in the DCB.

4.4. Drive Motor Feeder IRT - Test Form

- 4.4.1. Ring out motor drive feeders to ground to confirm location in the panel supplying the motors in the appropriate power station.
- 4.4.2. Label the conductors with the appropriate permanent ID at the power station, but DO NOT terminate them.
- 4.4.3. Once all the conductors have been cut, stripped and labeled they are now ready to be IRT tested.
- 4.4.4. To test individual conductors, isolate all conductors on both ends and connect the two phases not to be tested to ground. Connect one lead of the tester to ground and the other lead to the conductor to be tested.

- 4.4.5. Apply test voltage to the cable as specified in Table 1. Record the data from the meter on the test form.
- 4.4.6. Terminate the drive motor feeders to the correct locations at both the power station and in the Motor Control Unit.

Table 1: Insulation Resistance Test Summary			
Test	Test Voltage	Test Duration	Pass/Fail Range
IRT of DCB Feeders in 1000V system	1500V DC	30 seconds or until the reading settles	<p>≥ 50 Mohms - pass</p> <p>< 50 Mohms, ≥ 2 Mohms- investigate</p> <p>< 2 Mohms - fail</p>
IRT Drive Motor Feeders	500V DC	10 seconds or until the reading settles	<p>≥ 50 Mohms - pass</p> <p>< 50 Mohms, ≥ 2 Mohms- investigate</p> <p>< 2 Mohms - fail</p>

4.5. Recombiner Box (DCB) Inspection

Safety Note: Confirm that the array feeders terminating in the DCBs for the inverter block being inspected have not been energized.

Note: JSI will provide the subcontractor with an inspection sheet which, at a minimum, will cover the following items.

- 4.5.1. Verify all the main DCB disconnect switches for the specific power station being inspected are in the open position.
- 4.5.2. In the DCB verify that all negative and positive fuse holders in all DCBs for the specific power station are open.
- 4.5.3. Verify that the main disconnect handle on the door is engaged with the switch shaft and is operational.
- 4.5.4. Verify that the DCB is level and correctly installed with all trash removed within and around the DCB.
- 4.5.5. Visually inspect all DC field terminations in the DCB and confirm that they are correctly terminated and labeled in a neat and workman like manner.
- 4.5.6. Check that all mechanical electrical connections are properly tightened to the correct torque and marked with a torque mark.
- 4.5.7. Verify the correct installation, number and size of the ground conductor terminations.

JSI will inspect all combiner boxes and review testing documentation DC-1 and DC-2 after the subcontractor has terminated and inspected the combiner boxes and before combiner box energization. The combiner boxes will be energized only after JSI approval.

4.6. String Voc and Isc Testing

- 4.6.1. Testing should be done under a clear or mostly clear sky with the arrays in the horizontal position. If current readings are below [TBD] amps or voltage below [TBD] V due to cloudy conditions the test is inconclusive and must be stopped. Once a window of clear sky and stable conditions are present, the testing can resume.
- 4.6.2. Confirm all array strings are twenty [TBD] modules in series per string and are wired together correctly.
- 4.6.3. Confirm that all wiring is clipped to the module frames racking and are laying in the cable trays in a neat manner.
- 4.6.4. Connect arrays to the array feeders, energizing the combiner boxes up to the array side of the fuse holders.
- 4.6.5. Record the current weather conditions and monitor the cloud movement to ensure that there will be steady periods of sunlight or consistent conditions to proceed with testing the string. Do not test if a cloud casts a shadow on any part of the array.
- 4.6.6. Make sure the selector knob on the tester is in the voltage reading position, (POSITION 0). Attach the negative test lead onto the negative bus bar in the combiner box and the positive lead onto the positive bus bar.
- 4.6.7. Insert a fuse into each the positive and negative fuse block for the array feeder being tested. Close the fuse blocks and record the voltage and polarity for the test forms.
- 4.6.8. Once the voltage has been recorded turn the selector knob to the current reading position (POSITION 1), **but for no longer than 3 seconds**, read the current and then turn the selector knob immediately back to the voltage reading position (POSITION 0).

Note: If the connection between the meter leads and the bus bar is broken or the fuse blocks opened while the current is being measured (position 1) there will be an arc and damage causes to the equipment at the subcontractors expense.

- 4.6.9. Record the current measurement on the test form.
- 4.6.10. Measure the voltage between the ground and the positive array feeder and the ground and the negative array feeder and record the results.
- 4.6.11. Open the fuse blocks, remove fuses from the first block and place in the next blocks for the next array feeder to be tested. Follow the same procedure until all array feeders in a combiner box have been tested. After review of the test result and possible troubleshooting of specific strings by JSI, corrective action and retesting may be required.
- 4.6.12. Install all array feeder fuses, lock and tag out main DCB switch.



VOLTAGE TESTING POSITION



CURRENT TESTING POSITION

(This is the default position!)

4.7 DCB Feeder Polarity and Voltage Tests - Test Form – DC-7

- 4.7.1 Confirm that Tests DC-1, 3, 4 and 5 are complete and have been approved by JSI personnel.
- 4.7.2 Terminate all DCB feeders in the Power Station DC termination cabinet. Voltage measurements between positive and negative, positive and ground and negative and ground will be taken. Alligator clamp 1000V DC multimeter leads to the terminations of the first set of DCB feeders or a feeder to ground depending on the voltage to be tested. Close the termination cabinet as best as possible.
- 4.7.3 Confirm with all involved parties that the DCB feeders are ready and can safely be energized.
- 4.7.4 **Following proper LOTO procedures** remove the LOTO device and communicate the DCB number, via radio, to the personnel at the corresponding inverter termination cabinet. By saying:

“Ready to energize PSx.Ey.Cz”

The personnel at the power station DC termination cabinet should stand clear of the cabinet and communicate to the person at the DCB

“All clear”

- 4.7.5 The person at the DCB, before switching, should communicate:

“Energizing PSx.Ey.Rz”

- 4.7.6 The person at the DCB should close the DCB disconnect.
- 4.7.7 Once the DCB feeder circuit is energized the person at the DCB should communicate:

“PSx.Ey.Rz is energized”

- 4.7.8 The personnel at the power station termination cabinet will then use an appropriately rated voltmeter to measure and record the polarity and voltage.
- 4.7.9 **If the polarity is not correct**, communicate to the person at the DCB:

“Reverse Polarity. Open the disconnect”

Once the DCB disconnect is opened, the person at the DCB should communicate:

“PSx.Ey.Rz is OPEN.”

Confirm with the appropriately rated voltmeter that the circuit is open and drained of capacitive voltage. Switch the terminations and labeling.

- 4.7.10 **If the polarity is correct**, record the measurement and communicate:

“Measurement Complete Open the disconnect”

Once the DCB disconnect is opened, the person at the DCB should communicate:

“PSx.Ey.Rz is OPEN.”

- 4.7.11 After completing all required testing for an DCB including positive to ground and negative to ground in a similar fashion, LOTO the switch in the open position until startup.
5. **AC Electrical Tests [These tests are site specific and will be updated upon execution of EPC contract]**
 6. **Interconnection Tests [These tests are site specific and will be updated upon execution of EPC contract]**

EXHIBIT F
SAMPLE REPORT FROM FIRM MARKET PRICE INDEX
(see attached)

Trade Date	Begin Date	End Date	High	Low	Avg	Chg	Vol (MWH)	# Deals	# Cparties
Palo Verde Peak									
Jul 1, 2009	Jul 3, 2009	Jul 3, 2009	35.00	32.50	33.29	-2.95	22,800	53	17
Jul 2, 2009	Jul 6, 2009	Jul 6, 2009	35.00	30.25	31.30	-1.99	18,400	41	12
Jul 6, 2009	Jul 7, 2009	Jul 7, 2009	35.50	30.00	31.42	.12	19,600	46	20
Jul 7, 2009	Jul 8, 2009	Jul 8, 2009	35.00	32.00	33.32	1.90	23,200	57	23
Jul 8, 2009	Jul 9, 2009	Jul 9, 2009	32.50	31.00	32.00	-1.32	32,400	74	19
Jul 9, 2009	Jul 10, 2009	Jul 11, 2009	32.75	31.00	32.21	.21	64,800	72	21
Jul 10, 2009	Jul 13, 2009	Jul 13, 2009	38.50	36.00	36.49	4.28	35,600	85	24
Jul 13, 2009	Jul 14, 2009	Jul 14, 2009	42.75	38.00	40.63	4.14	27,600	65	22
Jul 14, 2009	Jul 15, 2009	Jul 15, 2009	45.00	44.00	44.51	3.88	27,600	60	20
Jul 15, 2009	Jul 16, 2009	Jul 16, 2009	45.75	44.00	45.11	.60	25,600	60	22
Jul 16, 2009	Jul 17, 2009	Jul 18, 2009	42.50	39.50	41.22	-3.89	68,000	71	22
Jul 17, 2009	Jul 20, 2009	Jul 20, 2009	45.75	42.50	43.65	2.43	22,400	56	17
Jul 20, 2009	Jul 21, 2009	Jul 21, 2009	50.00	46.50	48.13	4.48	14,000	35	18
Jul 21, 2009	Jul 22, 2009	Jul 22, 2009	49.25	44.00	47.39	-7.4	26,400	63	23
Jul 22, 2009	Jul 23, 2009	Jul 23, 2009	46.25	43.50	45.05	-2.34	22,800	55	21
Jul 23, 2009	Jul 24, 2009	Jul 25, 2009	45.65	42.75	43.57	-1.48	40,800	50	19
Jul 24, 2009	Jul 27, 2009	Jul 27, 2009	46.50	42.50	43.60	.03	15,600	35	17
Jul 27, 2009	Jul 28, 2009	Jul 28, 2009	47.50	45.25	45.97	2.37	17,200	43	21
Jul 28, 2009	Jul 29, 2009	Jul 30, 2009	43.00	41.75	42.45	-3.52	36,000	43	20
Jul 29, 2009	Jul 31, 2009	Jul 31, 2009	39.25	38.00	38.92	-3.53	16,000	39	19
Jul 30, 2009	Aug 1, 2009	Aug 1, 2009	37.00	34.00	36.26	-2.66	19,600	49	20
Jul 31, 2009	Aug 3, 2009	Aug 3, 2009	38.25	36.50	37.44	1.18	19,200	46	18
Aug 3, 2009	Aug 4, 2009	Aug 4, 2009	40.00	37.25	39.38	1.94	13,200	29	16
Aug 4, 2009	Aug 5, 2009	Aug 5, 2009	39.00	38.00	38.74	-.64	14,800	34	15
Aug 5, 2009	Aug 6, 2009	Aug 6, 2009	38.00	36.50	37.52	-1.22	18,400	44	20
Aug 6, 2009	Aug 7, 2009	Aug 8, 2009	37.00	35.25	36.10	-1.42	44,000	55	19
Aug 7, 2009	Aug 10, 2009	Aug 10, 2009	40.00	36.75	38.53	2.43	20,000	47	18
Aug 10, 2009	Aug 11, 2009	Aug 11, 2009	43.00	36.25	41.83	3.30	20,000	50	16
Aug 11, 2009	Aug 12, 2009	Aug 12, 2009	40.25	36.50	38.99	-2.84	18,800	40	18
Aug 12, 2009	Aug 13, 2009	Aug 13, 2009	37.25	32.50	35.35	-3.64	16,000	40	18
Aug 13, 2009	Aug 14, 2009	Aug 15, 2009	34.25	31.00	32.45	-2.90	44,000	51	16
Aug 14, 2009	Aug 17, 2009	Aug 17, 2009	37.25	31.25	34.15	1.70	27,200	63	19
Aug 17, 2009	Aug 18, 2009	Aug 18, 2009	33.25	29.00	31.61	-2.54	15,200	33	17

Trade Date	Begin Date	End Date	High	Low	Avg	Chg	Vol (MWH)	# Deals	# Cparties
Palo Verde Off-Peak									
Jul 1, 2009	Jul 3, 2009	Jul 4, 2009	23.50	21.50	22.51	.24	28,000	32	12
Jul 2, 2009	Jul 5, 2009	Jul 6, 2009	23.00	22.00	22.79	.28	32,000	37	11
Jul 6, 2009	Jul 7, 2009	Jul 7, 2009	19.00	17.25	17.85	-4.94	8,400	42	12
Jul 7, 2009	Jul 8, 2009	Jul 8, 2009	18.25	17.25	17.89	.04	8,200	35	16

EXHIBIT G

APPROVED LICENSED PROFESSIONAL ENGINEERS

SAIC/RW Beck
Black & Veatch
EAPC
GL Garrad Hassan
Power Engineers

EXHIBIT H

PERMITS

Millard County Zoning Districts Map Amendment
Millard County Conditional Use Permit
Millard County Building Permit
Millard County Driveway Encroachment Permit
Utah Department of Environmental Quality Authorization to Discharge under the UPDES Storm Water General Permit for Construction Activities
Commission Approval of Agreement
Self-Certification of Facility as QF

EXHIBIT 2.7

PACIFICORP'S INITIAL DESIGNATED REPRESENTATIVES

Authorized Representatives:

PacifiCorp: Director, Origination
PacifiCorp Energy
825 NE Multnomah St., Suite 600
Portland, OR 97232-2315
Fax 503-813-6271

With a copy to: Manager, Contract Administration
PacifiCorp Commercial and Trading
825 NE Multnomah St., Suite 600
Portland, OR 97232-2315
Fax 503-813-6271

EXHIBIT 3.2.3

REQUIRED FACILITY DOCUMENTS

Qualifying Facility Number from FERC:

1. Obtained Required Facility Documents:

Permits:

Land Rights:

2. To Be Obtained (Prior to Notice to Proceed) Required Facility Documents:

Licenses, Permits and Authorizations:

Millard County

1. Zoning Districts Map Amendment
2. Conditional Use Permit
3. Building Permit
4. Driveway Encroachment Permit

Utah Department of Environmental Quality

1. Authorization to Discharge under the UPDES Storm Water General Permit for Construction Activities

PacifiCorp Transmission

1. Executed Generation Interconnection Agreement

3. To Be Obtained (Prior to Commercial Operation) Required Facility Documents:

Licenses, Permits and Authorizations:

EPA

1. Spill Prevention Control and Countermeasure Plan (SPCC)

PacifiCorp

1. Access Easement for Pavant Substation Property

FERC

1. Self certification of the Project as a QF by submitting Form 556 to the Federal Energy Regulatory Commission ("FERC") per 18 C.F.R. § 292.207

Commission

1. Agreement approval

Construction and Operations and Maintenance:

Contract to engineer, procure and construct the Facility between juwi solar Inc. (or its affiliate) and Seller

Engineering and Procurement contract between Seller and Interconnection Provider

Retail Electric Service Agreement

Proof of Insurance

Operations and Maintenance Agreements:

Operation and Maintenance Agreement between juwi solar Inc. (or its affiliate) and Seller

SUCH LIST MAY BE UPDATED PURSUANT TO SECTION 3.2.3

EXHIBIT 3.2.5

LEASES

Exhibit 3.2.5 is Confidential and is provided in the confidential version of this filing

EXHIBIT 4.6(1)

GREEN TAG ATTESTATION AND BILL OF SALE

Pavant Solar II LLC (“Seller”) hereby sells, transfers and delivers to Buyer the Green Tags (including all Environmental Attributes and Green Tag Reporting Rights) associated with the generation and delivery of energy to PacifiCorp under the Power Purchase Agreement (Renewable Energy - Solar) between Seller and PacifiCorp dated [_____] (the “PPA”), as described below, in the amount of one Green Tag for each megawatt hour generated. Defined terms used in this Green Tag Attestation and Bill of Sale (as indicated by initial capitalization) shall have the meaning set forth in the PPA.

Facility name and location: _____ Fuel Type: Solar
Capacity (MW AC): _____ Operational Date: _____
Energy Admin. ID no.: _____

<u>Dates</u>	<u>MWh generated</u>
_____	_____

Seller further attests, warrants and represents, under penalty of perjury, as follows:

- i) to the best of its knowledge, the information provided herein is true and correct;
- ii) its sale to Buyer is its one and only sale of all or any part of the Green Tags referenced herein;
- iii) the Facility generated and delivered to the grid the energy in the amount indicated above pursuant to the PPA; and
- iv) to the best of Seller’s knowledge, each of the Green Tags associated with the generation of energy for delivery under the PPA have been generated and sold by the Facility.

This Green Tag Attestation and Bill of Sale confirms, in accordance with the PPA, the transfer from Seller to PacifiCorp all of Seller’s right, title and interest in and to the Green Tags associated with the generation of the energy from the Facility under the PPA as set forth above.

Seller's Contact Person: [_____]

WITNESS MY HAND,

[SELLER],

a [_____] [_____]

By _____

Its _____

Date: _____

This Attestation may be disclosed by Seller and PacifiCorp to others, including the Center for Resource Solutions, to substantiate and verify the accuracy of PacifiCorp's advertising and public communication claims, as well as in PacifiCorp's advertising and other public communications.

EXHIBIT 4.6(2)

QUALIFIED REPORTING ENTITY SERVICES AGREEMENT

C & T Master v2.2a; 032613

This Qualified Reporting Entity Services Agreement (this "Agreement") is entered into by and between PacifiCorp ("PacifiCorp") and _____ ("Counterparty"; PacifiCorp and Counterparty may be referred to individually herein as "Party" and collectively as "Parties") as of the date signed by both Parties with reference to the following:

WHEREAS, Counterparty represents to PacifiCorp that it owns or otherwise has the rights to all or part of the non-energy attributes of the generation from that certain electric generation facility as such rights are defined in that power purchase agreement between PacifiCorp and Counterparty for the Facility more particularly described on Exhibit A hereto (the "Facility"), or other rights respecting the Facility itself enabling it to lawfully enter hereinto; and

WHEREAS, The Western Renewable Electricity Generation Information System ("WREGIS") is a system tracking quantities of renewable energy generation generated by electric generating facilities in the nature of the Facility, as a Facility pursuant to WREGIS Terms of Use ("TOU"); and

WHEREAS, WREGIS requires that each Facility have a designated Qualified Reporting Entity; and

WHEREAS, Counterparty is an Account Holder in WREGIS and wishes to register the Facility with WREGIS; and

WHEREAS, Counterparty wishes to retain PacifiCorp to act as its WREGIS-defined Qualified Reporting Entity ("QRE") for the Facility;

NOW THEREFORE, in consideration of the mutual promises herein contained, the Parties agree as follows:

I. Definitions; Rules of Construction.

1.1 Initially capitalized terms used and not otherwise defined herein are defined in the in the Operating Rules or in Attachment 1 *Definitions* of the WREGIS TOU.

1.2 "Affiliate" means, with respect to any entity, each entity that directly or indirectly controls, is controlled by, or is under common control with, such designated entity, with "control" meaning the possession, directly or indirectly, of the power to direct management and policies, whether through the ownership of voting securities or by contract or otherwise. Notwithstanding the foregoing, with respect to PacifiCorp, Affiliate shall only include MidAmerican Energy Holdings Company and its direct, wholly owned subsidiaries.

1.3 “Business Day” means a day of the week other than Saturday, Sunday, or a federal holiday.

1.4 “Electric System Authority” means each of NERC, WECC, WREGIS, an RTO, a regional or sub-regional reliability council or authority, and any other similar council, corporation, organization or body of recognized standing with respect to the operations of the electric system in the WECC region.

1.5 “FERC” means the Federal Energy Regulatory Commission.

1.6 “Generation Interconnection Agreement” means the agreement entered into separately between Counterparty and Interconnection Provider concerning the Interconnection Facilities.

1.7 “Facility” is defined in the Preamble.

1.8 “Interconnection Facilities” means all the facilities installed, or to be installed, for the purpose of interconnecting the Facility to the System, including electrical transmission lines, upgrades, transformers and associated equipment, substations, relay and switching equipment, and safety equipment.

1.9 “Interconnection Provider” means the FERC-regulated or United States Department of Energy entity with whom the Facility has contracted for interconnection to the electric transmission grid; in the event Interconnection Provider is PacifiCorp, PacifiCorp would be the Interconnection Provider operating in its regulated transmission function, and not as the party hereto.

1.10 “Metering External Webpage” means a website owned and operated by PacifiCorp that PacifiCorp may at its option, but without being obligated to do so, make available and operate for the display of all data that will be included in the Monthly Generation Extract File.

1.11 “Monthly Generation Extract File” means a data file that contains generation data from Counterparty’s Points of Metering and conforms to the characteristics and requirements set forth in the WREGIS Interface Control Document.

1.12 “NERC” means the North American Electric Reliability Corporation.

1.13 “Points of Metering” means the points at which electric generation is measured.

1.14 “Prudent Electrical Practices” means any of the practices, methods and acts engaged in or approved by a significant portion of the electrical utility industry or any of the practices, methods or acts, which, in the exercise of reasonable judgment in the light of the facts known at the time a decision is made, could have been expected to accomplish the desired result at the lowest reasonable cost consistent with reliability, safety and expedition. Prudent Electrical

Practices is not intended to be limited to the optimum practice, method or act to the exclusion of all others, but rather to be a spectrum of possible practices, methods or acts.

1.15 “QRE” means a WREGIS-defined Qualified Reporting Entity.

1.16 “Renewable” is defined in section 2 of the WREGIS Operating Rules.

1.17 “Requirements of Law” means any applicable federal, state and local law, statute, regulation, rule, code or ordinance enacted, adopted, issued or promulgated by any federal, state, local or other Governmental Authority or regulatory body (including those pertaining to electrical, building, zoning, environmental and occupational safety and health requirements).

1.18 “Settlement Estimation Procedures” means a calculation based on standard utility estimation rules using algorithms developed and approved by PacifiCorp’s billing department.

1.19 “System” means the electric transmission substation and transmission or distribution facilities owned, operated or maintained by Transmission Provider, which shall include, after construction and installation of the Facility, the circuit reinforcements, extensions, and associated terminal facility reinforcements or additions required to interconnect the Facility, all as set forth in the Generation Interconnection Agreement.

1.20 “Tariff” means PacifiCorp FERC Electric Tariff Fifth Revised Volume No. 11 Pro Forma Open Access Transmission Tariff.

1.21 “Transmission Provider” means the FERC-regulated or United States Department of Energy entity with whom the Facility has contracted for electric transmission at and away from the Facility to any point on, or interconnection with, the electric transmission grid; in the event Transmission Provider is PacifiCorp, PacifiCorp would be the Interconnection Provider operating in its regulated transmission function, and not as the party hereto.

1.22 “Wholesale Generation Also Serving On-Site Loads” is defined in section 2 of the WREGIS Operating Rules.

1.23 “WECC” means the Western Electricity Coordinating Council.

1.24 “WREGIS” means the Western Renewable Energy Generation Information System.

1.25 “WREGIS Certificate” or “Certificate” means “Certificate” as defined by the WREGIS Operating Rules.

1.26 “WREGIS Operating Rules” means the operating rules and requirements adopted by WREGIS, including the TOU.

1.27 General Rules of Interpretation. Unless otherwise required by the context in which any term appears, (a) the singular includes the plural and vice versa; (b) references to

“Articles,” “Sections,” “Schedules,” “Annexes,” “Appendices” or “Exhibits” are to articles, sections, schedules, annexes, appendices or exhibits hereof; (c) all references to a particular entity or an electricity market price index include a reference to such entity’s or index’s successors; (d) “herein,” “hereof” and “hereunder” refer to this Agreement as a whole; (e) all accounting terms not specifically defined herein shall be construed in accordance with generally accepted accounting principles consistently applied; (f) the masculine includes the feminine and neuter and vice versa; (g) “including” means “including, without limitation” or “including, but not limited to”; (h) all references to a particular law or statute mean that law or statute as amended from time to time; and (i) the word “or” is not necessarily exclusive.

1.28 Interpretation with FERC Orders. Each Party conducts and shall conduct its operations in a manner intended to comply with FERC Order No. 717, Standards of Conduct for Transmission Providers, requiring the separation of its transmission and merchant functions. Moreover, the Parties acknowledge that each of Transmission Provider’s and Interconnection Provider’s transmission function offers transmission service on its system in a manner intended to comply with FERC policies and requirements relating to the provision of open-access transmission service. Counterparty agrees to conduct itself and operate the Facility in accordance with all Requirements of Law, all requirements of all applicable Electric System Authorities, and all requirements of the Interconnection Agreement.

1.28.1 Counterparty agrees to enter into the Generation Interconnection Agreement with the Interconnection Provider. The Generation Interconnection Agreement shall be a separate and free standing contract and the terms hereof are not binding upon the Interconnection Provider or Transmission Provider, although both are express third party beneficiaries hereof.

1.28.2 Notwithstanding any other provision in this Agreement, nothing in the Generation Interconnection Agreement, nor any other agreement between Counterparty on the one hand and Transmission Provider or Interconnection Provider on the other hand, nor any alleged event of default thereunder, shall alter or modify the Parties’ rights, duties, and obligation hereunder. Likewise, nothing herein or connected with the performance by PacifiCorp hereof shall affect or impair the rights of Interconnection Provider or Transmission Provider, under the Interconnection Agreement or otherwise. This Agreement shall not be construed to create any rights between Counterparty and the Interconnection Provider or between Counterparty and the Transmission Provider.

1.28.3 Counterparty expressly recognizes that, for purposes hereof, the Interconnection Provider and Transmission Provider each shall be deemed to be a separate entity and separate contracting party from PacifiCorp whether or not the Generation Interconnection Agreement is entered into with Interconnection Provider or an affiliate thereof. Counterparty acknowledges that PacifiCorp, acting in its merchant capacity function as purchaser hereunder, has no responsibility for or control over Interconnection Provider or Transmission Provider, and is not liable for any breach of agreement or duty by Interconnection Provider or Transmission Provider. Nothing in this Agreement shall operate to diminish, nor shall this Agreement extend to, Interconnection Provider or Transmission Provider’s use, retention, or disclosure of Counterparty or Facility information (including information within the scope of this Agreement)

in connection with PacifiCorp operating in its transmission function, including its carrying out of its obligations and business practices as a Balancing Authority or activities undertaken pursuant to the Tariff.

II. Term and Termination.

2.1 This Agreement shall be effective upon execution by the Parties and shall continue in effect until such time as either Party, upon providing 60 days written notice to the other Party, chooses to terminate. PacifiCorp may initiate any regulatory proceedings it deems appropriate to terminate this Agreement prior to the effectiveness of such termination. Notwithstanding the foregoing, (a) Counterparty may terminate this Agreement upon an event of default by PacifiCorp if PacifiCorp does not cure such event of default within 10 days of written notice; (b) PacifiCorp may terminate this Agreement upon an event of default by Counterparty if Counterparty does not cure such event of default within 10 days of written notice, (c) PacifiCorp may terminate this Agreement if the Facility fails to meet the requirements of Section 3.1 hereof and such failure is not cured within 30 days, and (d) Either Party may terminate this Agreement immediately upon notice to the other if Counterparty or the Facility fail to comply with Section 1.28. This Agreement may also be terminated as otherwise set forth herein.

III. QRE Services.

3.1 QRE Services. PacifiCorp will, on the terms set forth herein, serve as a QRE for the Facility so long as the Facility meets the definition of Renewable, is within the metered boundaries of both PacifiCorp's Balancing Authority and is equipped with either: (1) Transmission Provider or Interconnection Provider (as applicable) owned and operated meters; or (2) meters that meet the Interconnection Provider's requirements and (3) meet all applicable WREGIS requirements.

3.2 Compensation to PacifiCorp. In exchange for the services performed by PacifiCorp hereunder, Counterparty shall pay PacifiCorp as follows: Counterparty shall pay PacifiCorp a one-time initial setup fee of \$280, which shall be due upon execution of this Agreement. The Counterparty shall pay PacifiCorp a monthly reporting fee of \$50 per generating unit for which PacifiCorp reports output to WREGIS, provided that PacifiCorp may, in its discretion, assess and bill for all fees due hereunder on an annual, rather than monthly, basis. Other than the initial setup fee, which shall be due in advance, all other fees due hereunder shall be due within ten days of PacifiCorp's issuance of an invoice for such fees. PacifiCorp will review costs associated with this service on an annual basis, and may make necessary adjustments to the monthly reporting fee charged herein. Any change in the monthly reporting fee will become effective only after a minimum thirty (30) days prior written notice to Counterparty. In the event WREGIS, WECC, or any other entity with the ability or jurisdiction to modify the QRE reporting process requires a change that materially increases the costs to PacifiCorp of providing QRE services, PacifiCorp may pass those costs to the Counterparty by increasing the monthly reporting fee. PacifiCorp will use best efforts to provide Counterparty with prior notice before billing Counterparty for such increased costs. The fees set forth herein relate to PacifiCorp serving as a QRE for Counterparty pursuant to the terms of this Agreement. The necessary metering is a prerequisite for this service and is not covered in the fees described above.

3.3 Points of Metering. The Points of Metering that PacifiCorp will use are set forth in Exhibit A. Counterparty certifies that all Points of Metering listed in Exhibit A measure data only from Facility that meet the definition of Renewable. Counterparty shall notify PacifiCorp at least thirty (30) Business Days prior to making any proposed material changes to the Points of Metering. Following such notification, the Parties will decide whether such changes are mutually acceptable. If such changes are not acceptable to PacifiCorp, PacifiCorp may terminate this Agreement.

3.4 Expenses. Except as otherwise provided in the Interconnection Agreement (and in such case, only vis-à-vis Interconnection Provider), Counterparty shall bear all costs and expenses, including those incurred by PacifiCorp, relating to all metering or other equipment installed to accommodate Counterparty's Facility.

3.5 Reporting. Counterparty hereby grants to PacifiCorp sole and exclusive permission and authority to report Data and Output to WREGIS and warrants and represents that neither Counterparty nor any other person or entity acting on behalf of Counterparty has granted, or will hereafter grant during the term hereof any similar data reporting authority or permission to any other QRE or WREGIS Account Holder or to any other party or Agent for use in WREGIS, or any other energy tracking system, for the Facility. As a precondition for PacifiCorp to be able to perform hereunder, Counterparty shall submit Counterparty's Output data to PacifiCorp by allowing PacifiCorp to collect such data, at the Points of Metering, and report such data in the manner set forth herein.

3.5.1 Monthly Generation Extract File. Once a month PacifiCorp shall submit a Monthly Generation Extract File to WREGIS on Counterparty's behalf, which will conform to the characteristics and data requirements set forth in the WREGIS Interface Control Document.

3.5.2 Reporting Cycle. PacifiCorp shall submit the Monthly Generation Extract File to WREGIS no sooner than the last business day of each month for data collected during the previous month, or previous portion of month. PacifiCorp shall submit such data no later than sixty days following the end date of the output being reported.

3.5.3 Verification. Should PacifiCorp choose at its option to operate and make available a Metering External Webpage, PacifiCorp may in its reasonably exercised discretion grant Counterparty access for Counterparty to verify such information as prescribed by PacifiCorp from time to time, and to timely notify PacifiCorp in writing of any errors Counterparty detects.

3.5.4 Adjustments. After PacifiCorp submits the Monthly Generation Extract File to WREGIS, any information contained in the Monthly Generation Extract File shall be final for purposes of WREGIS reporting, subject only to the adjustment procedures set forth in the WREGIS Operating Rules, which shall be Counterparty's responsibility to implement if necessary.

3.6 Obligations of Counterparty. Counterparty shall report and provide to PacifiCorp accurate and complete generation Data and Output information for the Facility. Counterparty shall send the Data and other Output Information in a format and in compliance with any protocols which PacifiCorp may specify to Counterparty. Counterparty has a continuing duty to immediately notify PacifiCorp, if and when any generation Data or Output information has been sent in error or ceases to be truthful, accurate, or complete and to supply the corrected data as soon as practical, but not later than five (5) Business Days from the date Counterparty discovers that discrepancy in the Data or Output information.

3.7 WREGIS Fees. Counterparty is solely responsible for the payment directly to WREGIS of any and all WREGIS fees and costs that are required to register Counterparty's Facility and, to the extent the Generator Owner is a WREGIS Account Holder, Counterparty is responsible for the payment directly to WREGIS of all other WREGIS fees incident to the reporting of Generator Data and Output to WREGIS. Counterparty acknowledges and agrees that PacifiCorp shall have no obligation to advance or make payment of WREGIS fees or costs on Counterparty's behalf. Upon request by PacifiCorp made if PacifiCorp has received such a request from WREGIS or any regulator or third party, Counterparty shall provide PacifiCorp with evidence of payment of WREGIS fees and costs; failure to provide such information to PacifiCorp, upon request, shall constitute an event of default under this Agreement.

3.8 WREGIS Accounts. Counterparty will be solely responsible to make arrangements and registrations and for entering into any such agreements that are necessary to establish transfer of Certificates directly to proper Accounts or Subaccounts of Counterparty. Counterparty agrees that such arrangements shall preclude the need for PacifiCorp to act as custodian of such Certificates or to be responsible in any way to hold such Certificates in any Account or Subaccount of PacifiCorp or bear any responsibility, possession, obligation, or risk of loss with respect to Certificates created, held, or owned, with respect to the Facility. Counterparty acknowledges that, pursuant to section 11 of the WREGIS TOU, any generation data that PacifiCorp, acting as a QRE, provides to WREGIS shall reside in WREGIS and Counterparty will have no control over such data's use other than that provided for under the WREGIS TOU.

3.9 Obligations of PacifiCorp. PacifiCorp shall specify for Counterparty the protocols, reporting frequency, data file formats, and communication protocols for reporting generating Data, or Output, as necessary. PacifiCorp shall timely report to WREGIS Counterparty Data and/or Output information as specified in the most current WREGIS Interface Control Document (ICD). PacifiCorp shall not use or disclose Counterparty generation Data for any other purpose than reporting the Data to WREGIS, except as may be required by law, the Public Utility Commission of Oregon, any other state, federal, municipal or other regulator or governmental authority with jurisdiction over PacifiCorp or any of its assets, or a court of competent jurisdiction or as required under the terms of an existing agreement between the Parties. PacifiCorp shall not use Generator Owner generation Data for any other purpose. Notwithstanding the foregoing, PacifiCorp shall not be responsible for handling, account administration, transfer, evidence of, or any determination of Counterparty Certificate ownership or any other obligations for Certificates of Counterparty with regard to Certificates; and Counterparty shall bear all responsibility for such handling, account administration, evidence of,

or any determination of Counterparty Certificate ownership and all other obligations pertaining to creation and ownership of such Certificates.

3.10 Measurement.

3.10.1 Meter Data. Counterparty authorizes PacifiCorp's metering services organization to provide Counterparty's meter data directly to WREGIS in the form of the Monthly Generation Extract File. Counterparty authorizes PacifiCorp to gather data from the Points of Metering listed in Exhibit A. All such data is considered data which Counterparty has created and submitted to PacifiCorp, notwithstanding that PacifiCorp, rather than Counterparty will gather it.

3.10.2 Wholesale Generation Also Serving On-Site Loads. If Counterparty has any Wholesale Generation Also Serving On-Site Loads (as defined in Article One above), such Facility will need to have the on-site load generation metered (and registered) separately from the generation that is supplied to the grid, in accordance with the WREGIS Operating Rules. Otherwise, PacifiCorp will not report any data from such Facility. If such Facility exist, they must be specified in Exhibit A.

3.10.3 Estimates. When meter readings are not available due to meter hardware failure or data that is determined to be invalid due to meter malfunction or calibration or configuration error, to the extent deemed by PacifiCorp to be appropriate and permitted pursuant to WREGIS TOU, PacifiCorp will, if possible, rely on readings from redundant meters whether such meters are PacifiCorp owned or not. If readings from redundant meters are not possible, PacifiCorp will estimate and report meter data according to PacifiCorp's Settlement Estimation Procedures.

3.10.4 Responsibility. Counterparty is solely responsible for the data created and submitted to PacifiCorp, acting as a QRE, to forward to WREGIS.

3.11 Regulatory Requirements. PacifiCorp may release information provided by Counterparty hereunder, or gathered by PacifiCorp in connection herewith, to comply with any regulatory requirements applicable to PacifiCorp or if requested by a PacifiCorp regulator or if required by any other federal law or court order. Counterparty waives all applicable provisions of the Tariff which require PacifiCorp to hold confidential information with respect to the Generator Owner and the Facility, to the extent necessary for PacifiCorp to report, as a QRE, generation Data and Output regarding the Generation Unit(s) and to carry out PacifiCorp's obligations under this Agreement. This provision shall survive any termination of this Agreement.

3.12 Grant by Counterparty. Counterparty hereby grants to, permits, and authorizes PacifiCorp the following:

3.12.1 PacifiCorp is hereby authorized to communicate and transact with WREGIS as Counterparty's sole and exclusive reporting source of generation data for the Facility, and WREGIS is hereby authorized to communicate and transact directly with

PacifiCorp regarding any generation data issues for the Facility. PacifiCorp is hereby authorized to act on behalf of Counterparty, but only to the extent that PacifiCorp has lawful, contractual access to WREGIS.

3.12.2 PacifiCorp is hereby authorized to provide WREGIS with all generation data for the Facility that WREGIS requires, including, but not limited to, data required for preparation of required reports and billing.

3.12.3 PacifiCorp is authorized to undertake all actions which are reasonable and necessary to carry out the obligations set forth in the subsections above.

3.12.4 Counterparty retains all other rights and responsibilities and all other obligations to WREGIS.

IV. Indemnity and Hold Harmless by Counterparty.

4.1 Indemnity. To the extent permitted by Requirements of Law, Counterparty hereby indemnifies and agrees to hold PacifiCorp, its officers, employees, agents, or representatives, harmless for any and all liability that is in any way associated with PacifiCorp's performance hereunder. This includes liability arising from: the data contained in the Monthly Generation Extract File, or any other financial injury, or damage to persons or property. Without limiting the generality of the foregoing:

4.1.1 Waiver of Causes of Action and Claims for Damages. Counterparty hereby waives any and all causes of action arising under or in respect to this Agreement, whether in contract, tort or any other legal or equitable theory (including strict liability) against PacifiCorp. In no event shall PacifiCorp be liable to Counterparty its board of directors, employees, agents, or representatives for any demands, direct costs, lost or prospective profits or any other losses, liabilities or expenses, whether special, punitive, exemplary, consequential, incidental, or indirect in nature, that are in any way associated with PacifiCorp's performance of the QRE function or otherwise under or in respect of this Agreement.

4.2 Indemnity by Counterparty. Counterparty shall release, indemnify and hold harmless PacifiCorp, its Affiliates, and each of its and their respective directors, officers, employees, agents, and representatives (collectively, the "PacifiCorp Indemnities") against and from any and all losses, fines, penalties, claims, demands, damages, liabilities, actions or suits of any nature whatsoever (including legal costs and attorney's fees, both at trial and on appeal, whether or not suit is brought) (collectively, "Liabilities") resulting from, or arising out of, or in any way connected with, the performance by Counterparty of its obligations hereunder, or relating to the Facility, for or on account of (i) injury, bodily or otherwise, to, or death of, or (ii) for damage to, or destruction or economic loss of property of, any person or entity, excepting only to the extent such Liabilities as may be caused by the gross negligence or willful misconduct of any person or entity within the PacifiCorp Indemnities.

4.3 NOTWITHSTANDING ANY OTHER PROVISION OF THIS AGREEMENT, COUNTERPARTY ASSUMES FULL RESPONSIBILITY AND RISK OF LOSS RESULTING

FROM (1) THE FAILURE TO SEND DATA IN A FORMAT SPECIFIED BY PACIFICORP, (2) THE FAILURE TO USE PROTOCOLS SPECIFIED BY PACIFICORP OR (3) THE SENDING OF ERRONEOUS, UNTRUTHFUL, INACCURATE, AND/OR INCOMPLETE GENERATING DATA TO PACIFICORP OR THE SENDING OF ERRONEOUS, UNTRUTHFUL, INACCURATE, AND/OR INCOMPLETE DATA BY PACIFICORP TO WREGIS. IN NO EVENT SHALL PACIFICORP BE LIABLE FOR ANY CONSEQUENTIAL, INCIDENTAL, SPECIAL, EXEMPLARY, OR OTHER INDIRECT LOSS OR DAMAGES RESULTING FROM ANY BREACH OF THIS AGREEMENT, WHETHER CAUSED BY THE NEGLIGENCE OR INTENTIONAL ACTIONS OF PACIFICORP (AND/OR ITS CONTRACTORS, AGENTS, AND EMPLOYEES), REGARDLESS OF WHETHER SUCH CLAIM FOR DAMAGES IS BASED IN CONTRACT, TORT, STRICT LIABILITY OR OTHERWISE. IN NO EVENT SHALL PACIFICORP BE LIABLE FOR ANY LOSS OR HARM SUFFERED BY COUNTERPARTY OR ANY THIRD PARTY DUE TO ANY ACTION OR INACTION BY PACIFICORP TAKEN HEREUNDER THAT CAUSES A FACILITY TO LOSE ANY CREDENTIALS, REGISTRATION OR QUALIFICATION UNDER THE RENEWABLE PORTFOLIO STANDARD OR SIMILAR LAW OF ANY STATE OR OTHER JURISDICTION.

4.4 PACIFICORP WILL NOT BE RESPONSIBLE FOR ANY DAMAGES RESULTING FROM ECONOMIC LOSS, LOSS OF USE, LOSS OF DATA, LOSS OF BUSINESS, LOSS OF PROFIT, LOSS OF PRODUCTION TAX CREDITS, LOSS OF SAVINGS OR REVENUE, LOSS OF GOODWILL, THE CLAIMS OF THIRD PARTIES (INCLUDING CUSTOMERS AND SHAREHOLDERS OR OTHER EQUITY OWNERS), PERSONAL INJURIES OR PROPERTY DAMAGES SUSTAINED BY THE COUNTERPARTY OR ANY THIRD PARTIES, EVEN IF PACIFICORP HAS BEEN NOTIFIED BY COUNTERPARTY (OR BY ANY THIRD PARTY) OF SUCH DAMAGES.

4.5 PACIFICORP DISCLAIMS ANY LIABILITY FOR AND COUNTERPARTY WAIVES ANY CLAIM FOR LOSS OR DAMAGE RESULTING FROM ERRORS, OMISSIONS, OR OTHER INACCURACIES IN ANY PART OF WREGIS OR THE REPORTS, CERTIFICATES OR OTHER INFORMATION COMPILED OR PRODUCED BY AND FROM OR INPUT INTO WREGIS USING COUNTERPARTY SUPPLIED GENERATION DATA, WHETHER OR NOT SUCH ERRORS, OMISSIONS OR INACCURACIES ARE DUE TO ERRONEOUS, UNTRUTHFUL, INCOMPLETE, OR INACCURATE INFORMATION INPUT BY PACIFICORP INTO WREGIS.

4.6 COUNTERPARTY HEREBY RELEASES PACIFICORP AND ANY OF ITS CONTRACTORS, AGENTS, AND EMPLOYEES FROM ANY AND ALL LIABILITY WITH RESPECT TO DAMAGES OR INJURIES INCURRED BY GENERATOR OWNER AS RELATES TO THE FOREGOING, EXCLUDING ANY ARISING AS A RESULT OF TORTIOUS AND INTENTIONALLY KNOWING OR RECKLESS CONDUCT BY PACIFICORP.

4.7 COUNTERPARTY ACKNOWLEDGES AND AGREES THAT, IN THE EVENT OF BREACH OF THIS CONTRACT OR ANY OTHER ACTION RESULTING IN

LOSS OR POTENTIAL LOSS OR DAMAGE TO COUNTERPARTY, THE SOLE RECOURSE TO GENERATOR/OWNER IS TERMINATION OF THIS AGREEMENT.

4.8 Counterparty agrees to defend, indemnify, and hold harmless PacifiCorp and its directors, officers, employees, and agents from and against any and all claims (including third-party claims); causes of action, whether in contract, tort, or any other legal theory (including strict liability); demands; damages; costs; liabilities,; losses and expenses (including reasonable attorney's fees and court costs) of any nature whatsoever, whenever arising, arising out of, resulting from, attributable to, or related to Counterparty generation Data our Output for: any inaccuracy, error, or delay in or omission of (i) any Data, information, or service, or (ii) the transmission or delivery of any Data, information, or service; any interruption of any such Data, Output, information, or service (whether or not caused by PacifiCorp); or any financial, business, commercial, or other judgment, decision, act, or omission made by any person or entity based upon or related to the information.

4.9 Interconnection. Counterparty shall have no claims hereunder against PacifiCorp, acting in its merchant function capacity, with respect to any requirements imposed by or damages caused by (or allegedly caused by) acts or omissions of the Transmission Provider or Interconnection Provider, in connection with the Generation Interconnection Agreement or otherwise. Counterparty shall defend, indemnify and hold PacifiCorp harmless against any liability arising due to Counterparty's performance or failure to perform under the Generation Interconnection Agreement. Counterparty's failure to obtain, or perform under, the Generation Interconnection Agreement, or its other contracts and obligations to, Transmission Provider or Interconnection Provider is not a Force Majeure.

4.10 THIS ARTICLE SHALL SURVIVE ANY TERMINATION OF THIS AGREEMENT, WHETHER SUCH TERMINATION IS BY PACIFICORP OR COUNTERPARTY, AND WHETHER OR NOT SUCH TERMINATION IS ON ACCOUNT OF A DEFAULT.

V. Further Counterparty Obligations.

5.1 No Sale. Nothing herein constitutes a sale or purchase of energy or renewable energy certificates to or by PacifiCorp.

5.2 PTCs. Counterparty shall bear all risks, financial and otherwise throughout the Term, associated with Counterparty's or the Facility's eligibility to receive production tax credits ("PTCs") or qualify for accelerated depreciation for Counterparty's accounting, reporting or tax purposes.

5.3 Further Assurances. At PacifiCorp's request, the Parties shall execute such documents and instruments as may be reasonably required to effect the essential intent and purposes hereof.

5.4 Station Service. Counterparty shall be responsible for arranging and obtaining, at its sole risk and expense, any station service required by the Facility.

5.5 Costs of Ownership and Operation. Without limiting the generality of any other provision hereof, Counterparty shall be solely responsible for paying when due (a) all costs of owning and operating the Facility in compliance with existing and future Requirements of Law and the terms and conditions hereof, and (b) all taxes and charges (however characterized) now existing or hereinafter imposed on or with respect to the Facility, its operation, or on or with respect to emissions or other environmental impacts of the Facility, including any such tax or charge (however characterized) to the extent payable by a generator of such energy or renewable energy certificates.

5.6 Coordination with System. Counterparty shall be responsible for the coordination and synchronization of the Facility and the Interconnection Facilities with the System, and shall be solely responsible for (and shall defend and hold PacifiCorp harmless against) any damage that may occur as a direct result of Counterparty's breach of the Generation Interconnection Agreement.

5.7 Data Request. Counterparty shall, promptly upon written request from PacifiCorp, provide PacifiCorp with data reasonably required for information requests from any Governmental Authorities, state or federal agency intervenor or any other party achieving intervenor status in any PacifiCorp rate proceeding or other proceeding before any governmental authority. Counterparty shall use best efforts to provide this information to PacifiCorp sufficiently in advance to enable PacifiCorp to review it and meet any submission deadlines.

5.8 Additional Information. Counterparty shall provide to PacifiCorp such other information respecting Counterparty or the Facility as PacifiCorp may, from time to time, reasonably request.

5.9 No Dedication. Nothing herein shall be construed to create any duty to, any standard of care with reference to, or any liability to any person not a Party hereto. No undertaking by one Party to the other under any provision hereof shall constitute the dedication of PacifiCorp's facilities or any portion thereof to Counterparty or to the public, nor affect the status of PacifiCorp as an independent public utility corporation or Counterparty as an independent individual or entity.

5.10 Required Policies and Coverages. Without limiting any liabilities or any other obligations of Counterparty hereunder, Counterparty shall secure and continuously carry with an insurance company or companies rated not lower than "B+" by the A.M. Best Company the insurance coverage specified in the Generation Interconnection Agreement.

VI. Representations and Warranties.

6.1 Mutual Representations and Warranties. Each Party represents and warrants to the other that: (i) it is duly organized and validly existing under the laws of the jurisdiction of its incorporation or organization; (ii) it has the corporate, governmental and other legal capacity and authority to enter hereinto and to perform its obligations hereunder; (iii) such execution and performance do not violate or conflict with any law, order or agreement applicable to it; (iv) it has all governmental and other authorizations that are required to have been obtained or

submitted by it with respect hereto, and they are in full force and effect; (v) its obligations hereunder are valid, binding and enforceable in accordance with their terms (subject to bankruptcy or similar laws affecting creditors' rights generally); and (vi) no Event of Default, or event which with notice and/or lapse of time would constitute such an Event of Default, has occurred and is continuing or would occur as a result of its entering into or performing its obligations hereunder.

6.2 Representations and Warranties of Counterparty. Counterparty hereby represents and warrants to PacifiCorp: (i) it is not relying upon any representations of PacifiCorp other than those expressly set forth herein; (ii) it has entered hereinto with a full understanding of the material terms and risks of the same, and it is capable of assuming those risks; (iii) it has made its trading and investment decisions based upon its own judgment and any advice from such advisors as it has deemed necessary and not in reliance upon any view expressed by PacifiCorp; (iv) it has not received from PacifiCorp any assurances or promises regarding any financial results or benefits hereunder; (v) service hereunder is not a utility service within the meaning of Section 466 of the United States Bankruptcy Code; and (vi) Counterparty holds legal title to the Facility or otherwise holds the legal right to cause the Facility to enter into this Agreement.

VII. Financial Responsibility.

7.1 Adequate Assurances. Without limiting PacifiCorp's rights under Article VIII hereof, if Counterparty has failed to make a timely payment hereunder, and PacifiCorp has reasonable grounds for insecurity regarding the performance of any obligation of Counterparty hereunder (whether or not then due), PacifiCorp may demand Adequate Assurances of Performance. "Adequate Assurances of Performance" means sufficient security in the form, amount, by an issuer or guarantor, and for the term reasonably acceptable to PacifiCorp, including, but not limited to, cash, a standby irrevocable letter of credit, a prepayment, a security interest in government securities, an asset or a performance bond or guaranty. Such Adequate Assurances of Performance shall be provided within three business days after a written demand is made by PacifiCorp.

VIII. Events of Default; Remedies.

8.1 Event of Default. "Event of Default" means, with respect to a Party (the "Defaulting Party"):

8.1.1 the failure to render when due any payment or performance hereunder, if such failure is not remedied within five days after written notice;

8.1.2 the failure to timely provide adequate assurances required pursuant to Article VII hereof;

8.1.3 any such Party's representation or warranty proves to have been incorrect or misleading in any material respect when made;

8.1.4 the failure to perform any other covenant set forth herein if such failure is not remedied within five days after written notice;

8.1.5 its bankruptcy, if adequate assurances acceptable to PacifiCorp and approved by the Bankruptcy Court are not provided;

8.1.6 the expiration or termination of any credit support of Counterparty's obligations hereunder (other than in accordance with its terms) prior to the satisfaction of all obligations of Counterparty without the written consent of PacifiCorp; or

8.1.7 In the case of Counterparty:

8.1.7.1 Counterparty fails to report generation Data or Output information to PacifiCorp for the Facility or Counterparty fails to send the data in a format and use the protocols specified by PacifiCorp as determined by PacifiCorp to be required to meet the requirements of the WREGIS Operating Rules;

8.1.7.2 Counterparty is delinquent in payment to WREGIS of any WREGIS fees for registration or maintenance of Accounts or Subaccounts, which payment impairs the ability of PacifiCorp to report Generator Data, Output, or other information to WREGIS regarding the Facility, which delinquency continues for a period of thirty (30) days;

8.1.7.3 Counterparty fails to comply with a request by PacifiCorp to provide evidence of payment of WREGIS fees pertaining to the Facility; or

8.1.7.4 Counterparty knowingly or intentionally falsifies or misrepresents any Data, Output information, or other information required by WREGIS.

8.2 Remedies Upon Event of Default. In the Event of Default by a Party and for so long as the Event of Default is continuing, the non-defaulting Party (the "Performing Party") shall have the right to do any or all of the following: (1) upon two business days' written notice to the Defaulting Party, terminate this Agreement; (2) withhold any payments or performance due in respect of this Agreement; and (3) exercise such other remedies as may be available at law or in equity or as otherwise provided for herein, to the extent such remedies have not been otherwise waived or limited pursuant to the terms hereof.

8.3 Setoff. If an Event of Default occurs, the Performing Party may, at its election, set off any or all amounts which the Defaulting Party owes to it or any Affiliate of the Performing Party (whether under this Agreement or otherwise and whether or not then due) against any or all amounts which it or any Affiliate of the Performing Party owes to the Defaulting Party (whether under this Agreement or otherwise and whether or not then due).

8.4 Payment of Damages. Any amounts due on account of default shall be paid by the close of business on the next business day following the Defaulting Party's receipt of the Performing Party's written termination notice setting forth the termination payment due.

8.5 Limitation of Liability. THE EXPRESS REMEDIES AND MEASURES OF DAMAGES PROVIDED HEREIN SATISFY THE ESSENTIAL PURPOSES HEREOF. FOR BREACH OF ANY PROVISION FOR WHICH AN EXPRESS REMEDY OR MEASURE OF DAMAGE IS PROVIDED, SUCH REMEDY OR MEASURE SHALL BE THE SOLE AND EXCLUSIVE REMEDY THEREFOR. LIABILITY THAT HAS NOT BEEN OTHERWISE EXCLUDED PURSUANT TO THE TERMS HEREOF SHALL BE LIMITED TO DIRECT ACTUAL DAMAGES ONLY AS THE SOLE AND EXCLUSIVE REMEDY. EXCEPT AS OTHERWISE SPECIFICALLY SET FORTH HEREIN, NO PARTY SHALL BE REQUIRED TO PAY OR BE LIABLE FOR SPECIAL, CONSEQUENTIAL, INCIDENTAL, PUNITIVE, EXEMPLARY, OR INDIRECT DAMAGES, LOST PROFIT OR BUSINESS INTERRUPTION DAMAGES, BY STATUTE, IN TORT, CONTRACT OR OTHERWISE.

8.6 Survival. This Article survives the expiration or termination hereof.

IX. Force Majeure.

9.1 Except with regard to a Party's obligation to make payments hereunder, in the event either Party hereto is rendered unable, wholly or in part, by Force Majeure to carry out its obligations with respect hereto, then upon such Party's (the "Claiming Party") giving notice and full particulars of such Force Majeure as soon as reasonably possible after the occurrence of the cause relied upon, such notice to be confirmed in writing or by facsimile to the other Party, then the obligations of the Claiming Party shall, to the extent they are affected by such Force Majeure, be suspended during the continuance of said inability, but for no longer period, and the Claiming Party shall not be liable to the other Party for, or on account of, any loss, damage, injury or expense resulting from, or arising out of such event of Force Majeure. The Party receiving such notice of Force Majeure shall have until the end of the Business Day following such receipt to notify the Claiming Party that it objects to or disputes the existence of an event of Force Majeure. "Force Majeure" means an event or circumstance which prevents one Party from performing its obligations hereunder, which event or circumstance was not anticipated, which is not within the reasonable control of, or the result of the negligence of, the Claiming Party, and which, by the exercise of due diligence, the Claiming Party is unable to overcome or avoid or cause to be avoided. Counterparty's failure to obtain, or perform under, the Generation Interconnection Agreement, or its other contracts and obligations to, Transmission Provider or Interconnection Provider is not a Force Majeure.

9.2 Force Majeure Does Not Affect Other Obligations. No obligations of either Party that arose before the Force Majeure causing the suspension of performance or that arise after the cessation of the Force Majeure shall be excused by the Force Majeure.

9.3 Strikes. Notwithstanding any other provision hereof, neither Party shall be required to settle any strike, walkout, lockout or other labor dispute on terms which, in the sole judgment of the Party involved in the dispute, are contrary to the Party's best interests.

X. Miscellaneous.

10.1 CHOICE OF LAW. This Agreement shall be interpreted and enforced in accordance with the laws of the state of Oregon, excluding any choice of law rules that may direct the application of the laws of another jurisdiction.

10.2 Restriction on Assignments. Neither Party may assign this Agreement or any of its rights or obligations hereunder without the prior written consent of the other Party, which consent shall not be unreasonably withheld. Any purported assignment in violation hereof shall be void ab initio. This Agreement inures to the benefit of and is binding upon the Parties and their respective successors and permitted assigns.

10.3 Notices. All notices, requests, statements or payments shall be made to the addresses set out on the Notices Exhibit. Notices required to be in writing shall be delivered by letter, facsimile or other documentary form. Notice by facsimile or hand delivery shall be deemed to have been given when received or hand delivered. Notice by overnight mail or courier shall be deemed to have been given on the date and time evidenced by the delivery receipt. The Parties may change any of the persons to whom notices are addressed, or their addresses, by providing written notice in accordance with this Section.

10.4 Entire Agreement; Counterparts. This Agreement constitutes the entire agreement between the Parties with respect to its subject matter. This Agreement may not be amended, changed, modified, or altered unless such amendment, change, modification, or alteration is in writing and signed by both Parties. This Agreement may be executed in counterparts, including by telefacsimile transmission, each of which is an original and all of which taken together constitute one and the same original instrument. This Agreement completely and fully supersedes all other prior understandings or agreements, both written and oral, between the Parties relating to the subject matter hereof. If any provision of this Agreement is determined to be invalid, void or unenforceable by any court of competent jurisdiction, such determination shall not invalidate, void, or make unenforceable any other provision, agreement or covenant of this Agreement, provided the basic purposes of this Agreement and the benefits to the Parties are not substantially impaired.

10.5 No Waiver. Waiver by a Party of any default by the other Party shall not be construed as a waiver of any other default, nor shall any delay by a Party in the exercise of any right under this Agreement be considered as a waiver or relinquishment thereof.

10.6 Jurisdiction. Any judicial action arising out of, resulting from or in any way relating to this Agreement shall be brought only in a state or federal court of Multnomah County, Oregon. In the event such judicial proceedings are instituted by either Party, the prevailing Party shall be entitled to award of its costs and attorneys' fees incurred in connection with such proceedings.

10.7 Jury Trial Waiver. THE PARTIES EACH HEREBY IRREVOCABLY WAIVE ALL RIGHT TO TRIAL BY JURY IN ANY ACTION, PROCEEDING OR COUNTERCLAIM ARISING OUT OF OR RELATING HERETO, ANY GREEN TAGS OR THE TRANSACTIONS CONTEMPLATED HEREBY. EACH PARTY FURTHER WAIVES ANY RIGHT TO CONSOLIDATE ANY ACTION IN WHICH A JURY TRIAL HAS BEEN WAIVED WITH

ANY OTHER ACTION IN WHICH A JURY TRIAL CANNOT BE OR HAS NOT BEEN WAIVED.

10.8 No Third Party Beneficiaries. With the exception of Transmission Provider and Interconnection Provider, who are express third party beneficiaries hereof, this Agreement confers no rights whatsoever upon any person other than the Parties and shall not create, or be interpreted as creating, any standard of care, duty or liability to any person not a Party hereto.

10.9 Relationship of the Parties. Nothing contained herein shall be construed to create an association, joint venture, trust, or partnership, or impose a trust or partnership covenant, obligation, or liability on or with regard to any one or more of the Parties. Each Party shall be individually responsible for its own covenants, obligations, and liabilities under this Agreement.

IN WITNESS WHEREOF, the Parties have executed this Agreement by their duly authorized representatives as of the date last below written.

PacifiCorp	<COUNTERPARTY>
By: _____	By: _____
Name: <u>Bruce Griswold</u>	Name: _____
Title: <u>Director, Short-Term Origination and QF Contracts</u>	Title: _____
Date: _____	Date: _____

Exhibit A
Facility and Generation Data

For Facility enter the following information:

Facility Name and Address or Location

Meter Number (Device ID)

Facility's WREGIS Generator ID

EIA or QF ID#

One-line diagram that includes description of meter locations at the facility – voltage and location

NOTICES EXHIBIT

To Counterparty: Jay Sonnenberg
juwi solar Inc.
1710 29th Street. Suite 1068
Boulder, Colorado 80301
E-mail: jsonnenberg@juwisolar.com

To PacifiCorp: PacifiCorp
825 NE Multnomah, Suite 600
Portland, Oregon 97232- 2315
Attn: Director, Origination
Telefacsimile (503) 813-6260
E-mail: rick.link@pacificorp.com

with a copy to: PacifiCorp
825 NE Multnomah, Suite 600
Portland, Oregon 97232- 2315
Attn: Manager of Contract Administration
Telefacsimile (503) 813-6291
E-mail: cntadmin@pacificorp.com

with copies to: PacifiCorp Legal Department
825 NE Multnomah, Suite 2000
Portland, Oregon 97232- 2315
Attn: Assistant General Counsel
Telefacsimile (503) 813-6761
E-mail: jeff.erb@pacificorp.com

EXHIBIT 5.1
CONTRACT PRICE

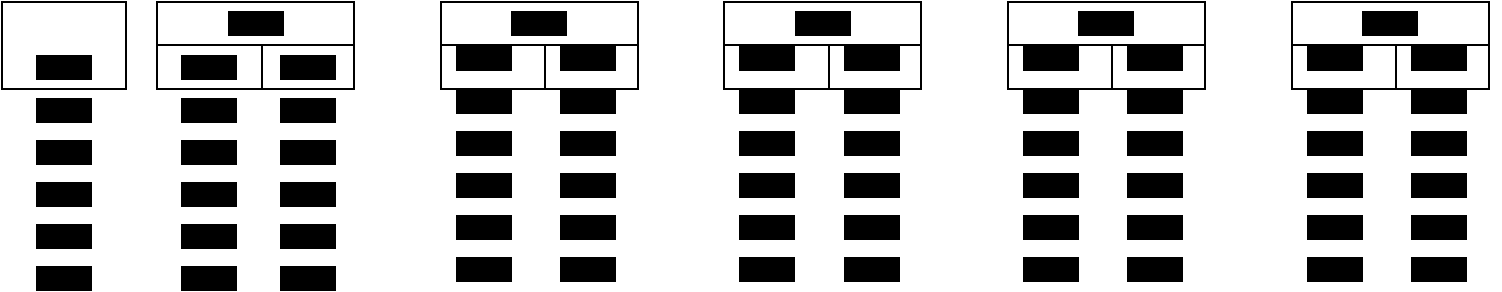
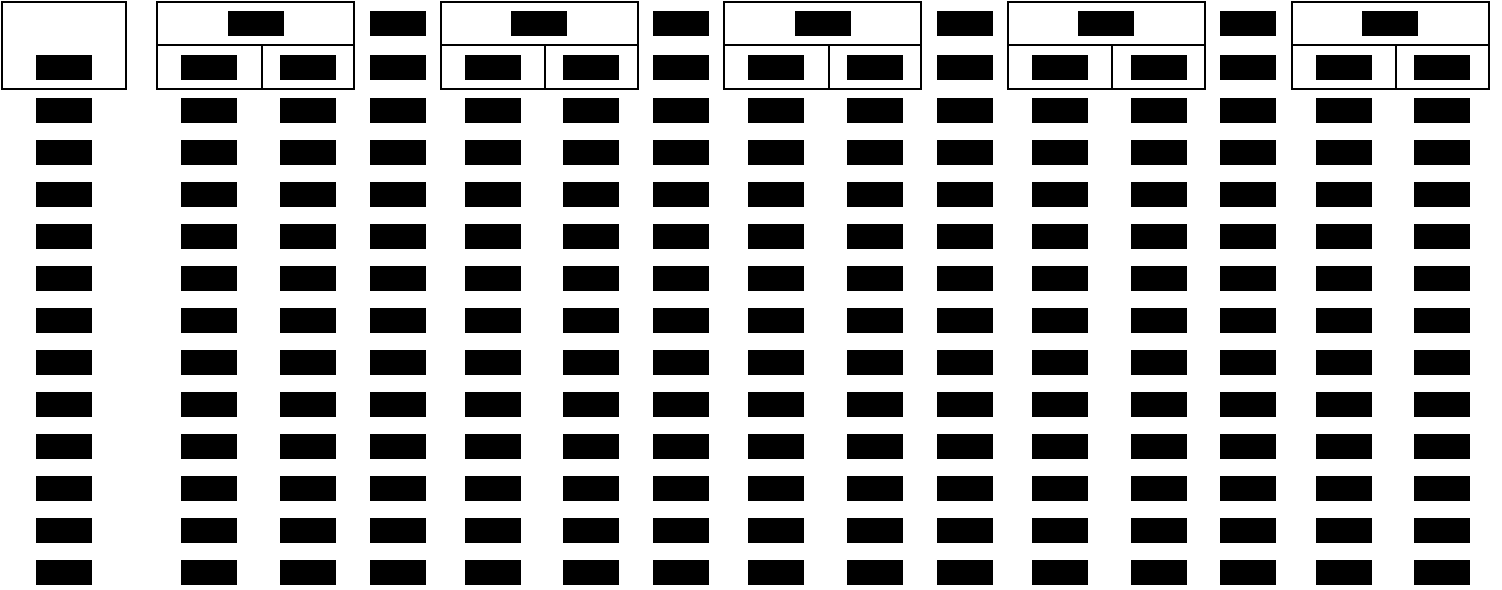
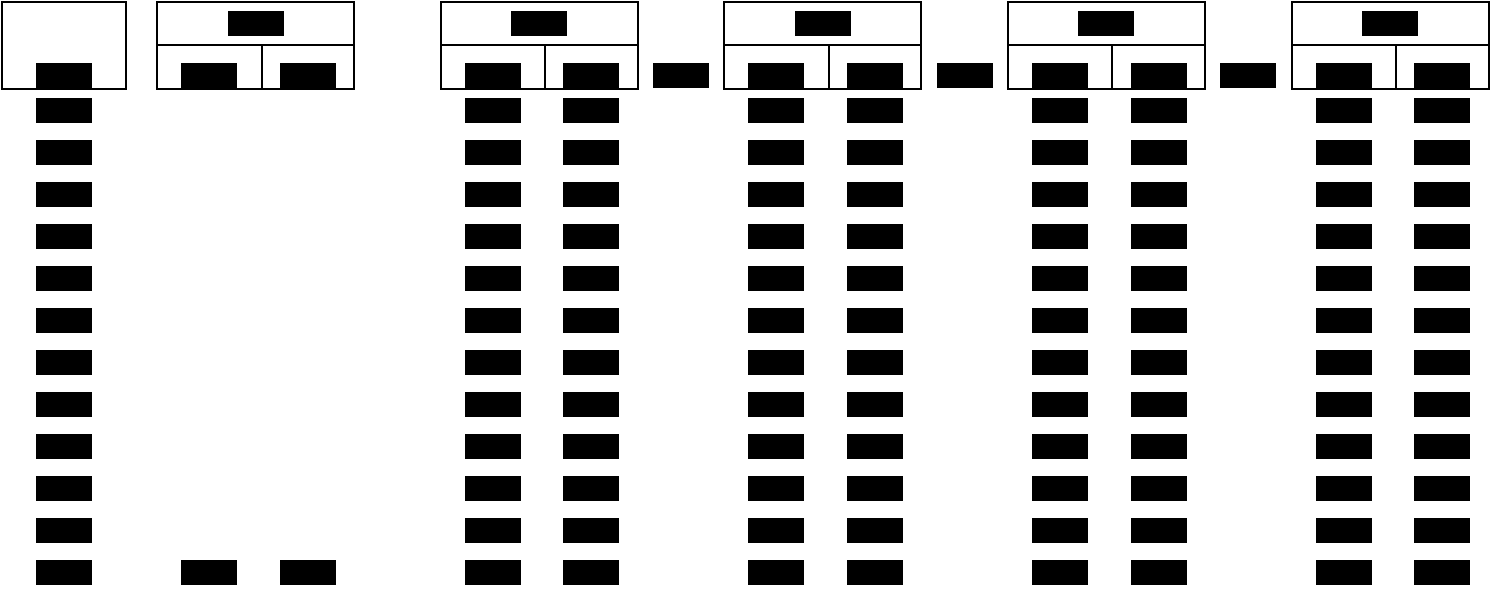

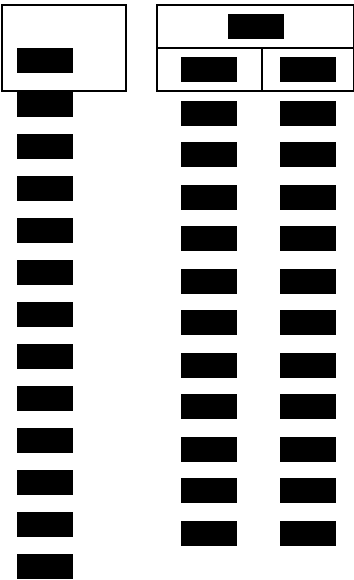
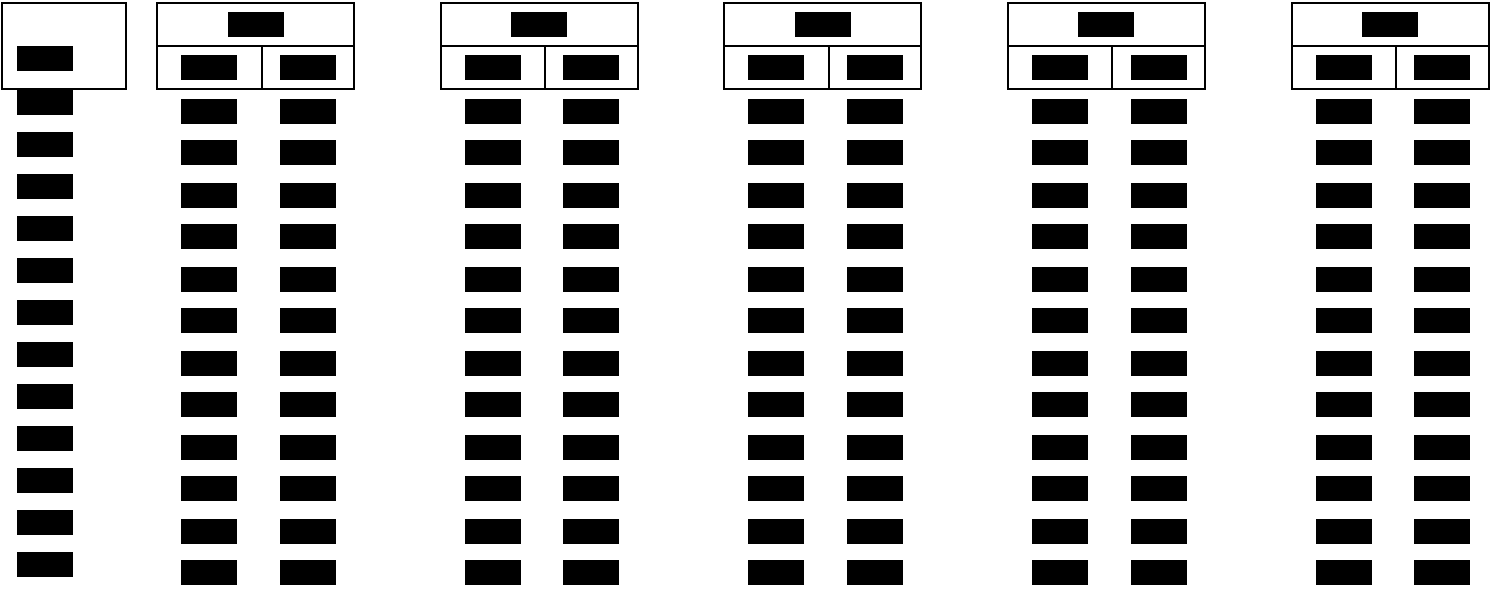
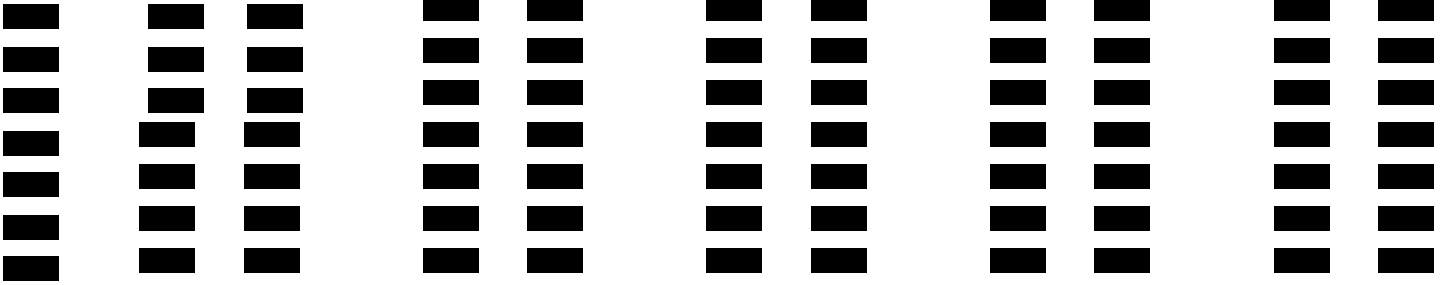

EXHIBIT 6.1

Description of Seller's Facility

[REDACTED]

[REDACTED]

[REDACTED]

[REDACTED]

[REDACTED]

[REDACTED]

[REDACTED]

[REDACTED]

[REDACTED]

[REDACTED]

[REDACTED]

[REDACTED]

[REDACTED]

[REDACTED]

[REDACTED]

[REDACTED]

[REDACTED]

[REDACTED]

[REDACTED]

[REDACTED]

[REDACTED]

[REDACTED]

[REDACTED]

[REDACTED]

[REDACTED]

[REDACTED]

[REDACTED]

[REDACTED]



EXHIBIT 6.1 — Attachments

1. Site Map

EXHIBIT 8.2.1

FORM OF GUARANTY — CREDIT SUPPORT SECURITY

THIS GUARANTY AGREEMENT (this "Guaranty"), dated as of _____, 20__, is issued and delivered by _____, a _____ corporation (the "Guarantor"), for the account of _____, a _____ limited liability company (the "Obligor"), and for the benefit of PacifiCorp, an Oregon corporation (the "Beneficiary").

Background Statement

WHEREAS, the Beneficiary and Obligor entered into that certain Power Purchase Agreement, dated as of _____, 20__ (the "Agreement"); and

WHEREAS, Guarantor delivers to the Beneficiary this Guaranty as an inducement to Beneficiary to enter into the Agreement.

Agreement

NOW, THEREFORE, in consideration of the foregoing and for good and valuable consideration, the Guarantor hereby agrees as follows:

1. Guaranty; Limitation of Liability. Subject to any rights, setoffs, counterclaims and any other defenses of Obligor under the Agreement that the Guarantor expressly reserves to itself under this Guaranty (except as set forth below), the Guarantor absolutely and unconditionally guarantees the timely payment of the Obligor's payment obligations under the Agreement (the "Guaranteed Obligations"); provided, however, that the Guarantor's aggregate liability hereunder shall not exceed Expenses as defined in Section 12, plus (a) _____ U.S. Dollars (U.S. \$_____) for the period from the date that is ten (10) days after the effective date of the Agreement, through but not including the date that is three (3) months after the effective date of the Agreement, (b) _____ (U.S.\$_____) for the period from the date that is three (3) months after the effective date of the Agreement through but not including the Commercial Operation Date (as defined in the Agreement), and (c) _____ U.S. Dollars (U.S. \$_____) for the period from the Commercial Operation Date (as defined in the Agreement) through the Expiration Date.

2. Subject to the other terms of this Guaranty, the liability of the Guarantor under this Guaranty is limited to Expenses as defined in Section 12, and payments expressly required to be made by Obligor under the Agreement, and except as specifically provided therein, the Guarantor shall not be liable for or required to pay any consequential or indirect loss (including but not limited to loss of profits), exemplary damages, punitive damages, special damages, or any other damages or costs.

3. Effect of Amendments. The Guarantor agrees that the Beneficiary and the Obligor may modify, amend and supplement the Agreement and that the Beneficiary may delay or extend the date on which any payment must be made pursuant to the Agreement or delay or extend the date on which any act must be performed by the Obligor thereunder, all without

notice to or further assent by the Guarantor, who shall remain bound by this Guaranty, notwithstanding any such act by the Beneficiary.

4. Waiver of Rights. The Guarantor expressly waives (i) protest, (ii) notice of acceptance of this Guaranty by the Beneficiary, (iii) demand for payment of any of the Guaranteed Obligations; (iv) any right to assert against Beneficiary any defense (legal or equitable), counter-claim, set-off, cross-claim or other claim that Guarantor may now or at any time hereafter have (a) against Obligor or (b) acquired from any other party, not affiliated with Guarantor, to which Beneficiary may be liable; and (v) any defense arising by reason of any claim or defense based upon an election of remedies by Beneficiary which in any manner impairs, affects, reduces, releases, destroys or extinguishes Guarantor's subrogation rights, rights to proceed against Obligor for reimbursement, or any other rights of the Guarantor to proceed against Obligor or against any other person, property or security.

5. Reservation of Defenses. Without limiting the Guarantor's own defenses and rights hereunder, the Guarantor reserves to itself all rights, setoffs, counterclaims and other defenses that the Obligor may have to payment of all or any portion of the Guaranteed Obligations except defenses arising from the bankruptcy, insolvency, dissolution or liquidation of the Obligor and other defenses expressly waived in this Guaranty.

6. Settlements Conditional. If any monies paid to the Beneficiary in reduction of the indebtedness of the Obligor under the Agreement have to be repaid by the Beneficiary by virtue of any provision or enactment relating to bankruptcy, insolvency or liquidation for the time being in force, the liability of the Guarantor under this Guaranty shall be computed as if such monies had never been paid to the Beneficiary.

7. Subrogation. The Guarantor shall be subrogated to all rights of the Beneficiary against the Obligor in respect of any amounts paid by the Guarantor pursuant to this Guaranty; provided, however, that the Guarantor hereby postpones all rights of subrogation, reimbursement, indemnity and recourse (including, without limitation, any statutory rights of subrogation under Section 509 of the Bankruptcy Code, 11 U.S.C. § 509, or otherwise) until such time as all amounts due under the Agreement are paid in full and Section 6 hereof fully, finally, and indefeasibly performed. If (i) the Guarantor shall perform and shall make payment to the Beneficiary of all or any part of the Guaranteed Obligations and (ii) all the then outstanding obligations under the Agreement have been paid in full, Beneficiary shall, at the Guarantor's request, execute and deliver to the Guarantor documents to evidence the transfer by subrogation to the Guarantor of any interest in the obligations under the Agreement resulting from such payment by the Guarantor.

8. Notice. The Beneficiary will provide written notice to the Guarantor if the Obligor defaults under the Agreement.

9. Primary Liability of the Guarantor. The Guarantor agrees that the Beneficiary may enforce this Guaranty without the necessity at any time of resorting to or exhausting any other security or collateral, howsoever arising. This is a continuing Guaranty of payment and not merely of collection.

10. Term of Guaranty. This Guaranty shall remain in full force and effect until the earlier of (i) such time as all the Guaranteed Obligations have been finally and indefeasibly discharged in full, and (ii) _____ (the "Expiration Date"); provided however, the Guarantor will remain liable hereunder for Guaranteed Obligations that were outstanding prior to the Expiration Date.

11. Governing Law. This Guaranty shall be governed by and construed in accordance with the internal laws of the State of Utah.

12. Expenses. The Guarantor agrees to pay all reasonable out-of-pocket expenses (including the reasonable fees and expenses of the Beneficiary's counsel) relating to the enforcement of the Beneficiary's rights hereunder in the event the Guarantor disputes its obligations under this Guaranty and it is finally determined (whether through settlement, arbitration or adjudication, including the exhaustion of all permitted appeals), that the Beneficiary is entitled to receive payment of a portion of or all of such disputed amounts; provided, however, that the Guarantor's aggregate liability for such expenses shall not exceed two hundred fifty thousand U. S. Dollars (U.S. \$250,000) ("Expenses").

13. Waiver of Jury Trial. The Guarantor and the Beneficiary, through acceptance of this Guaranty, waive all rights to trial by jury in any action, proceeding or counterclaim arising or relating to this Guaranty.

14. Entire Agreement; Amendments. This Guaranty integrates all of the terms and conditions mentioned herein or incidental hereto and supersedes all oral negotiations and prior writings in respect to the subject matter hereof. This Guaranty may only be amended or modified by an instrument in writing signed by each of the Guarantor and the Beneficiary.

15. Headings. The headings of the various Sections of this Guaranty are for convenience of reference only and shall not modify, define or limit any of the terms or provisions hereof.

16. No Third-Party Beneficiary. This Guaranty is given by the Guarantor solely for the benefit of the Beneficiary, and is not to be relied upon by any other person or entity.

17. Assignment. Neither the Guarantor nor the Beneficiary may assign its rights or obligations under this Guaranty without the prior written consent of the other, which consent may not be unreasonably withheld or delayed, except that:

(i) the Guarantor may make such an assignment without such consent if the assignee meets the Credit Requirements as defined in the Agreement, provided that the Guarantor's obligations hereunder must be expressly assumed in writing, in a form reasonably acceptable to the Beneficiary; provided further that such assumption shall be deemed to release the Guarantor from all of its obligations under this Guaranty automatically and without further action by the Guarantor or the Beneficiary, and

(ii) the Beneficiary may, upon 30 days prior written notice, make such an assignment without such consent if in conjunction with any assignment of the Agreement by the Beneficiary permitted under the Agreement. Any purported assignment in violation of this Section 17 shall be void and without effect.

18. Notices. Any communication, demand or notice to be given hereunder will be duly given when delivered in writing or sent by facsimile to the Guarantor or to the Beneficiary, as applicable, at its address as indicated below:

If to the Guarantor, at:

With a copy to:

If to the Beneficiary, at:

PacifiCorp
825 NE Multnomah Street, Suite 700
Portland, OR 97232
Attn: Credit Manager
Facsimile No.: 503-813-5609

With a copy to:

PacifiCorp Office of the General Counsel
825 NE Multnomah Street, Suite 700
Portland, OR 97232
Attn: Jeff Erb and Jeremy Weinstein
Facsimile No.: 503-813-6260 and 925-943-3105

or such other address as the Guarantor or the Beneficiary shall from time to time specify. Notice shall be deemed given (a) when received, as evidenced by signed receipt, if sent by hand delivery, overnight courier or registered mail or (b) when received, as evidenced by transmission confirmation report, if sent by facsimile and received on or before 4 pm local time of recipient, or (c) the next business day, as evidenced by transmission confirmation report, if sent by facsimile and received after 4 pm local time of recipient.

19. Jury Trial Waiver. TO THE FULLEST EXTENT PERMITTED BY LAW, EACH OF THE PARTIES HERETO WAIVES ANY RIGHT IT MAY HAVE TO A TRIAL BY JURY IN RESPECT OF LITIGATION DIRECTLY OR INDIRECTLY ARISING OUT OF, UNDER OR IN CONNECTION WITH THIS AGREEMENT. EACH PARTY FURTHER WAIVES ANY RIGHT TO CONSOLIDATE ANY ACTION IN WHICH A JURY TRIAL HAS BEEN WAIVED WITH ANY OTHER ACTION IN WHICH A JURY TRIAL CANNOT BE OR HAS NOT BEEN WAIVED.

IN WITNESS WHEREOF, the Guarantor has executed this Guaranty as of the day and year first above written.

By: _____
Name:
Title:

EXHIBIT 9.2

POINT OF DELIVERY/INTERCONNECTION FACILITIES

Instructions to Seller:

1. Include description of point of metering, and Point of Interconnection

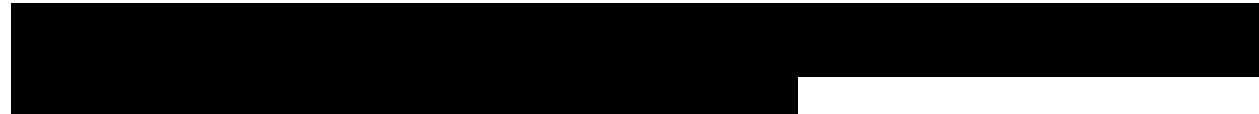

2. Include description of Point of Delivery

The Point of Delivery is the same location as the Point of Interconnection.

3. Provide interconnection single line drawing of Facility including any transmission facilities on Seller's side of the Point of Interconnection.

See Exhibit B

4. Provide transmission single line drawing of the transmission path from the Point of Interconnection to the Point of Delivery as the path is defined in the Transmission Agreement(s). Specify any changes of ownership along the transmission path. Specify the Transmission Agreement(s) governing each segment of Seller's transmission path, from the Point of Interconnection to the Point of Delivery.

N/A. The Project's Point of Interconnection is the same as its Point of Delivery.

5. Describe Seller's arrangements for station service to the facility and show on one-line diagram how station service will be provided and metered.

Under conditions where the PV plant is generating, the station services will be supplied by onsite generation. When the plant is not generating, the auxiliary power will be backfed from the Pavant Substation. Metering will be accomplished with a bidirectional meter.

6. Specify the maximum hourly rate (MW) at which Seller is permitted to deliver energy to the Point of Delivery and in compliance with Seller's transmission rights between the Point of Interconnection and the Point of Delivery ("Maximum Transmission Rate"):

■ MW.

EXHIBIT B – Attachments

1. Substation Metering One-Line Diagram

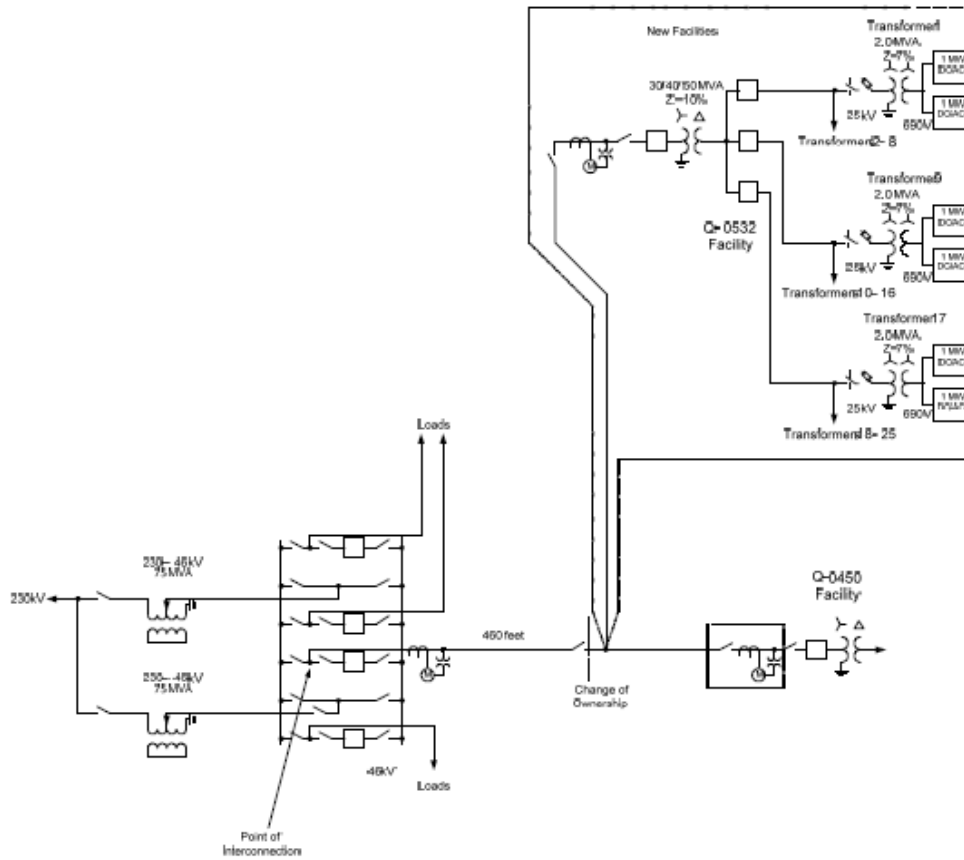

EXHIBIT 9.5

**SELLER AUTHORIZATION TO RELEASE GENERATION DATA TO
PACIFICORP**

[DATE]

Director, Transmission Services
PacifiCorp
825 NE Multnomah, Suite 1600
Portland, OR 97232

To Whom it May Concern:

_____ ("Seller") hereby voluntarily authorizes PacifiCorp's Transmission business unit to share Seller's interconnection information with Marketing Affiliate employees of PacifiCorp Energy, including but not limited to those in Commercial and Trading group. Seller acknowledges that PacifiCorp did not provide it any preferences, either operational or rate-related, in exchange for this voluntary consent.

EXHIBIT 11.4

FORM OF MEMORANDUM OF POWER PURCHASE AGREEMENT

WHEN RECORDED, MAIL TO:

PACIFICORP
825 NE Multnomah, Suite 2000
Portland, Oregon 97232-2315
Attn: Director, Origination and Manager of Contract Administration

MEMORANDUM OF POWER PURCHASE AGREEMENT

THIS MEMORANDUM OF POWER PURCHASE AGREEMENT ("Memorandum"), dated as of _____, 20__, is made by and between _____ a _____ limited liability company ("Seller"), and PACIFICORP, an Oregon corporation acting in its merchant function capacity ("PacifiCorp"). Seller and PacifiCorp are sometimes hereinafter referred to collectively as the "Parties" and individually as a "Party".

RECITALS

A. Seller and PacifiCorp have entered into that certain Power Purchase Agreement on the ___ day of _____, 20__ (the "Agreement"), pursuant to which Seller has agreed to construct, own, operate and maintain a solar-powered generation facility for the generation of electric energy to be located in Millard County, in the State of Utah (as more particularly defined in the Agreement, the "Project"), and upon completion of said Project, to sell to PacifiCorp the electric energy to be produced by the Project as well as all associated "Green Tags" (as that term is defined in the Agreement), all on the terms and conditions set forth in the Agreement. The real property on which the Project is to be constructed (the "Premises") is more particularly described in the attached Exhibit "A".

B. Seller and PacifiCorp desire to provide record notice of certain terms and conditions of the Agreement pertaining to the Parties' respective rights and obligations under the Agreement in the event the Agreement is terminated due to a default by Seller.

NOW, THEREFORE, in consideration of the mutual covenants and obligations set forth in the Agreement and this Memorandum, Seller and PacifiCorp agree as follows:

TERMS

1. The Premises. Seller acknowledges and agrees that the real property comprising the Premises, and all improvements and fixtures to be constructed thereon, including without limitation, the Project, is and will be owned by Seller and shall hereafter be held, sold, conveyed, transferred, assigned, subdivided, leased, rented, encumbered, occupied and used subject to and in accordance with the provisions of Sections 8.4 and 11.4 and 11.8 of the Agreement and this Memorandum.

2. Covenants Running with the Land. The provisions of Section 11.4 and

11.8 of the Agreement are and shall be deemed to be covenants running with the land and shall be binding upon and inure to the benefit of Seller and PacifiCorp and their respective successors and permitted assigns, including without limitation any person acquiring or owning an interest in the Premises or the Project, and their respective heirs, executors, successors, permitted assigns, administrators, devisees and representatives.

3. Notice.

a. Termination for Default. If this Agreement is terminated because of a default by Seller, neither Seller nor Affiliate, nor any successor to Seller with respect to the ownership of the Facility or Premise (for whom Seller acts herein as agent), may thereafter require or seek to require PacifiCorp to purchase energy or capacity from the Facility or any facility constructed on the Premise under the Public Utility Regulatory Policy Act ("PURPA"), or any other Requirements of Law, for any periods that would have been within the Term had this Agreement remained in effect. Seller, on behalf of itself and on behalf of any other entity on whose behalf it may act, hereby waives its rights to require PacifiCorp to do so. Seller, pursuant to Section 11.4 of the Agreement, has, on behalf of itself and its successors, waived its rights to require PacifiCorp to so purchase such energy from the Facility or a facility constructed on the Premise in the event of such termination. Terms not defined herein shall have the meaning ascribed to such terms in the Agreement.

b. Survival. The terms and provisions of Section 11.4 of the Agreement shall survive the termination of the Agreement.

4. Intentionally Deleted

5. Effect of Memorandum. This Memorandum, and the rights and obligations of the parties hereunder, are subject to all of the terms and conditions of the Agreement. The Agreement is hereby incorporated by reference as if fully set forth herein.

6. Counterparts. This Memorandum may be executed in any number of counterparts, each of which when executed and delivered shall be deemed an original, and all of which shall together constitute one and the same instrument.

7. Further Information. Further information regarding the specific terms and conditions of the Agreement may be requested from PacifiCorp at 825 NE Multnomah, Suite 2000, Portland, Oregon 97232-2315, Attn: Sr. Vice President, Commercial & Trading. Disclosure of any such information shall be subject to the terms and conditions of a written confidentially agreement acceptable to PacifiCorp in its sole and absolute discretion.

IN WITNESS WHEREOF, Seller and PacifiCorp have executed and acknowledged this Memorandum as of the day and year first above written.

PACIFICORP,
an Oregon corporation

By: _____ By: _____

Name:
Title:

Name:
Title:

STATE OF _____)
) ss
COUNTY OF _____)

The foregoing instrument was acknowledged before me this ____ day of _____, 2009 by _____, the _____ of _____, a _____ limited liability company.

NOTARY PUBLIC

STATE OF _____)
) ss
COUNTY OF _____)

The foregoing instrument was acknowledged before me this ____ day of _____, 2009, by _____, the _____ of PACIFICORP, an Oregon corporation.

NOTARY PUBLIC

Exhibit "A"

Legal Description of the Premises

EXHIBIT 13

REQUIRED INSURANCE

1.1 Required Policies and Coverages. Without limiting any liabilities or any other obligations of Seller under this Agreement, Seller shall secure and continuously carry with an insurance company or companies rated not lower than “A-/VII” by the A.M. Best Company the insurance coverage specified below:

1.1.1 Workers’ Compensation. Seller shall comply with any applicable laws or statutes, state or federal jurisdiction, where Seller performs work.

1.1.2 Employers’ Liability. Seller shall maintain employers’ liability insurance with minimum limits covering bodily injury for: \$500,000 – each accident, \$500,000 by disease – each employee, and \$500,000 by disease – policy limit.

1.1.3 Commercial General Liability. Seller shall maintain insurance to include premises and operations, contractual liability, with a minimum single limit of \$1,000,000 each occurrence to protect against and from loss by reason of injury to persons or damage to property based upon and arising out of the activity under this Agreement.

1.1.4 Business Automobile Liability. Seller shall secure and continuously carry business automobile liability insurance with a minimum single limit of \$1,000,000 each accident covering bodily injury and property damage with respect to Seller’s vehicles whether owned, hired or non-owned.

1.1.5 Umbrella/excess Liability. Seller shall maintain umbrella or excess liability insurance on an occurrence and following form basis with a minimum limits as follows:

- (a) Facility Capacity Rating under 200 KW - \$1,000,000
- (b) Facility Capacity Rating at or above 200 KW - \$5,000,000

1.1.6 Property Insurance. Seller shall maintain property insurance covering equipment and structures in an amount at least equal to the full replacement value for "all risks" of physical loss or damage, including coverage for earth movement, flood, boiler and machinery, and business interruption. The policy may contain separate sub-limits and deductibles subject to insurance company underwriting guidelines. Property insurance will be maintained in accordance with terms available in the insurance market for similar facilities.

1.2 Additional Provisions or Endorsements:

1.2.1 Except for workers’ compensation and property insurance, the policies required herein shall include provisions or endorsements as follows:

- (a) naming PacifiCorp, parent, divisions, officers, directors and employees as additional insureds;
- (b) include provisions that such insurance is primary insurance with respect to the interests of PacifiCorp and that any other insurance maintained by PacifiCorp is excess and not contributory insurance with the insurance required hereunder, and
- (c) cross liability coverage or severability of interest.

1.2.2 Unless prohibited by applicable law, all required insurance policies shall contain provisions that the insurer will have no right of recovery or subrogation against PacifiCorp.

1.3 Certificates. Prior to connection of the Facility to PacifiCorp's electric system, or another utility's electric system if delivery to PacifiCorp is to be accomplished by wheeling, Seller shall secure and continuously carry insurance in compliance with the requirements of this Section. Seller shall provide PacifiCorp insurance certificate(s) confirming Seller's compliance with the insurance requirements hereunder. Insurance certificate confirming compliance shall be provided to PacifiCorp by Seller at least annually and each time a new insurance policy is issued or becomes effective.

1.4 Commercial General Liability coverage written on a "claims-made" basis, if any, shall be specifically identified on the certificate, and Seller shall be maintained by Seller for a minimum period of five (5) years after the completion of this Agreement and for such other length of time necessary to cover liabilities arising out of the activities under this Agreement.

1.5 Periodic Review. PacifiCorp may review this schedule of insurance as often as once every two (2) years. PacifiCorp may in its discretion require Seller to make reasonable changes to the policies and coverages described in this Exhibit to the extent reasonably necessary to cause such policies and coverages to conform to the insurance policies and coverages typically obtained or required for power generation facilities comparable to the Facility at the time PacifiCorp's review takes place.